



WHAT'S NEXT
FOR IN-HOME
COMFORT



13451 Damar Dr Suite JK, Philadelphia PA 19116
Contact: (267) 722-4052
www.sanksmechanical.com



Carrier Ductless Systems



TABLE OF CONTENTS

Ductless Technology & Benefits	04
Ductless & VRF Product Lineup	16
Single Zone Products	20
Multi-Zone Products	48
Light Commercial Products	60
Glossary	99



ENHANCING YOUR IN-HOME COMFORT ONE ROOM AT A TIME

Ductless systems are becoming an increasingly popular HVAC choice in homes across the U.S. Why? Because not only can they heat and cool any space with precision—but, in most cases, they don't require ductwork, which provides homeowners with increased flexibility.

Often called “mini-splits,” ductless systems use the same process for heating and cooling as traditional systems. However, instead of delivering hot or cool air to an entire home (through ducts and vents), each ductless unit blows air directly into a single room. This allows for greater comfort control of individual spaces and improves energy efficiency and sustainability along the way.







Make Yourself at Home
MANET Jean-Jacques Lévesque
AMERICA THE BEAUTIFUL
THE TIMECHART OF MILITARY HISTORY
BALI SUSTAINABLE VISIONS

CARRIER. MAKING INDOOR SPACES MORE LIVABLE.

As a general rule of thumb, complete ductless systems include:



Indoor unit(s)
with a coil and
blower fan

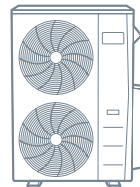

Outdoor unit
with a compressor,
coil and fan



Copper refrigerant tubing
and electrical wiring that
connects the indoor and
outdoor units

Carrier Ductless systems also use Inverter technology—which continually adjusts the compressor speed as conditions change for consistent temperatures, quiet operation and lower energy usage. Plus, enjoy year-round comfort with a system that performs in even the harshest of conditions.

With Carrier Ductless solutions on hand, any space can become a more comfortable place.

VERSATILE UNITS. STREAMLINED DESIGNS.

Almost every home has a room that always seems drafty or overheated. Perhaps it's a sunroom that gets too hot to be enjoyable or a master bedroom that's just not cool enough for sleeping.

Whatever the challenge, Carrier Ductless units meet virtually any application and installation need.



The High Wall is easily and quickly mounted directly to an interior wall



The Console is great for rooms where wall mounting isn't possible or desirable



The Ducted is a great example of a unit that's hidden from view (if ceiling space allows)



The Cassette can be mounted directly on the ceiling



The multipoise Air Handler uses existing ductwork to seamlessly replace traditional systems and furnaces



The Air Handler is the newest ductless unit in the Carrier lineup—a multi-poise unit that enables you to experience the benefits of ductless systems without changing your home's architecture.

And lastly (but perhaps most importantly), with their small footprint and narrow cabinets, ductless outdoor units can be strategically placed in a variety of space types. Minimize noise heard both indoors and from patios and other outdoor gathering spaces.

MORE OF WHAT YOU NEED & LESS OF WHAT YOU DON'T

It goes without saying that ductless systems have benefits to spare. Even the most challenging areas to control and maintain can be turned into comfortable, usable spaces with the addition of ductless.

ENHANCED COMFORT

- **Air Quality**—Each Carrier Ductless unit has removable, washable air filters inside. This helps prevent airborne particles from recirculating in your home's air, keeping it fresher and cleaner. Plus, our top-of-the-line systems allow you to precisely control humidity levels, so rooms never feel too damp or too dry.
- **Multi-Zone Capabilities**—Our multi-zone outdoor unit can connect and power several indoor units at the same time, which helps achieve the desired comfort level for every room.
- **Smart Controls**—Carrier Ductless systems have Wi-Fi® connectivity that lets you adjust settings from your smartphone, integrated sensors that can direct airflow toward the people in the room and third-party thermostat compatibility.
- **Quiet Operation**—Ultra-quiet operation reduces noise pollution both indoors and out for more peaceful, comfortable spaces.



GREATER SUSTAINABILITY

- **Energy Efficiency**—Ductless systems only use power when it's needed, reducing energy consumption and keeping costs down in tandem.
- **Energy Savings**—Carrier Ductless systems are Energy Star rated. And because they allow you to select which rooms to heat or cool (instead of an entire house), energy use is limited to those specific areas. This also helps offset the energy loss commonly experienced in older homes.
- **SEER** (Seasonal Energy Efficiency Ratio) measures the cooling efficiency of a system. The higher the SEER, the less energy needed to cool your home. 42.0 is the industry's highest rating—and, not coincidentally, right where some Carrier systems land.
- **HSPF** (Heating Seasonal Performance Factor) is how the heating efficiency of the system is measured. Just like SEER, the higher the HSPF number, the more efficient the heat pump. Carrier systems have an up to 15.0 HSPF rating.

**CARRIER DUCTLESS
SYSTEMS DON'T
JUST KEEP YOU
COMFORTABLE—
THEY ALSO HELP
THE PLANET AND
KEEP YOUR UTILITY
BILLS DOWN.**

IMPROVED APPLICATION FLEXIBILITY

RENOVATIONS & EXPANSIONS

The flexibility of ductless systems means they can be easily integrated into new architecture without having to accommodate for additional space between walls and ceilings. When converting an existing area that may not be connected to the central HVAC system into a new living space (i.e., a basement, attic or garage), ductless is a simple solution for providing comfort year-round.

EASY INSTALLATION

The system's refrigerant pipe and electrical cable enter the house through a three-inch hole in the wall. That's it! Installation is quick, non-intrusive and minimally disruptive to your space.

CONSISTENT TEMPERATURES

Have a room that's too hot or too cold? No problem. Ductless can help you target areas with uneven temperatures for more consistent comfort.

OLDER & HISTORIC HOMES

When your home doesn't have the space to add ductwork, ductless is an ideal solution that doesn't require costly renovations and installation.

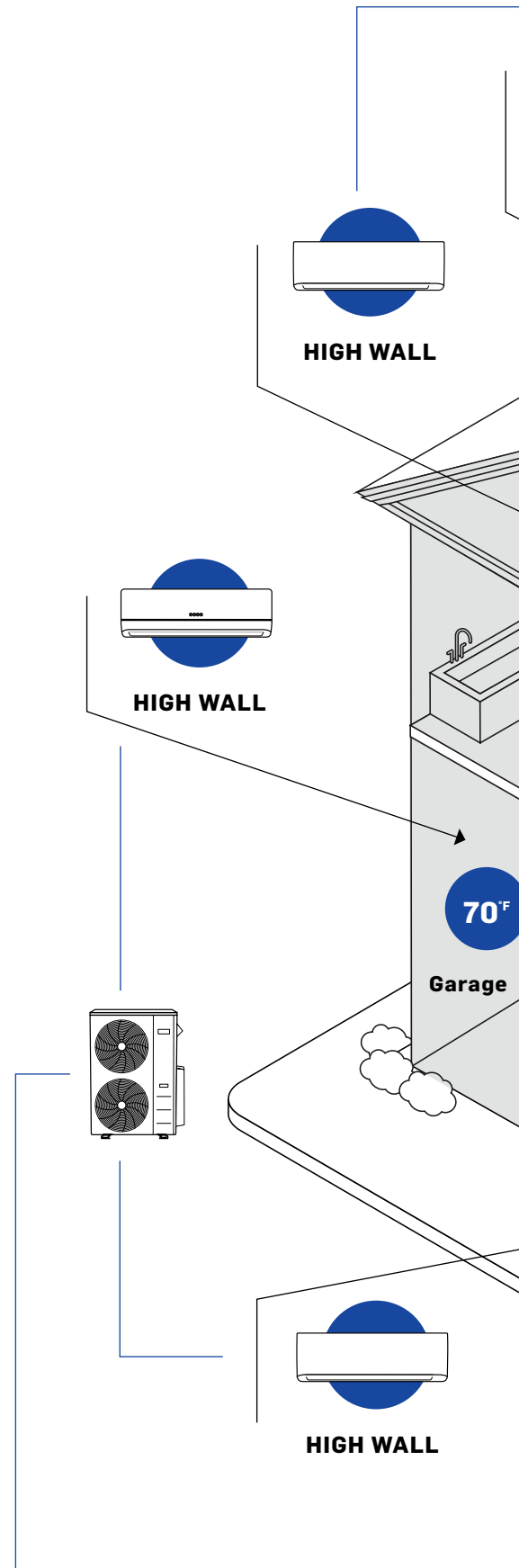

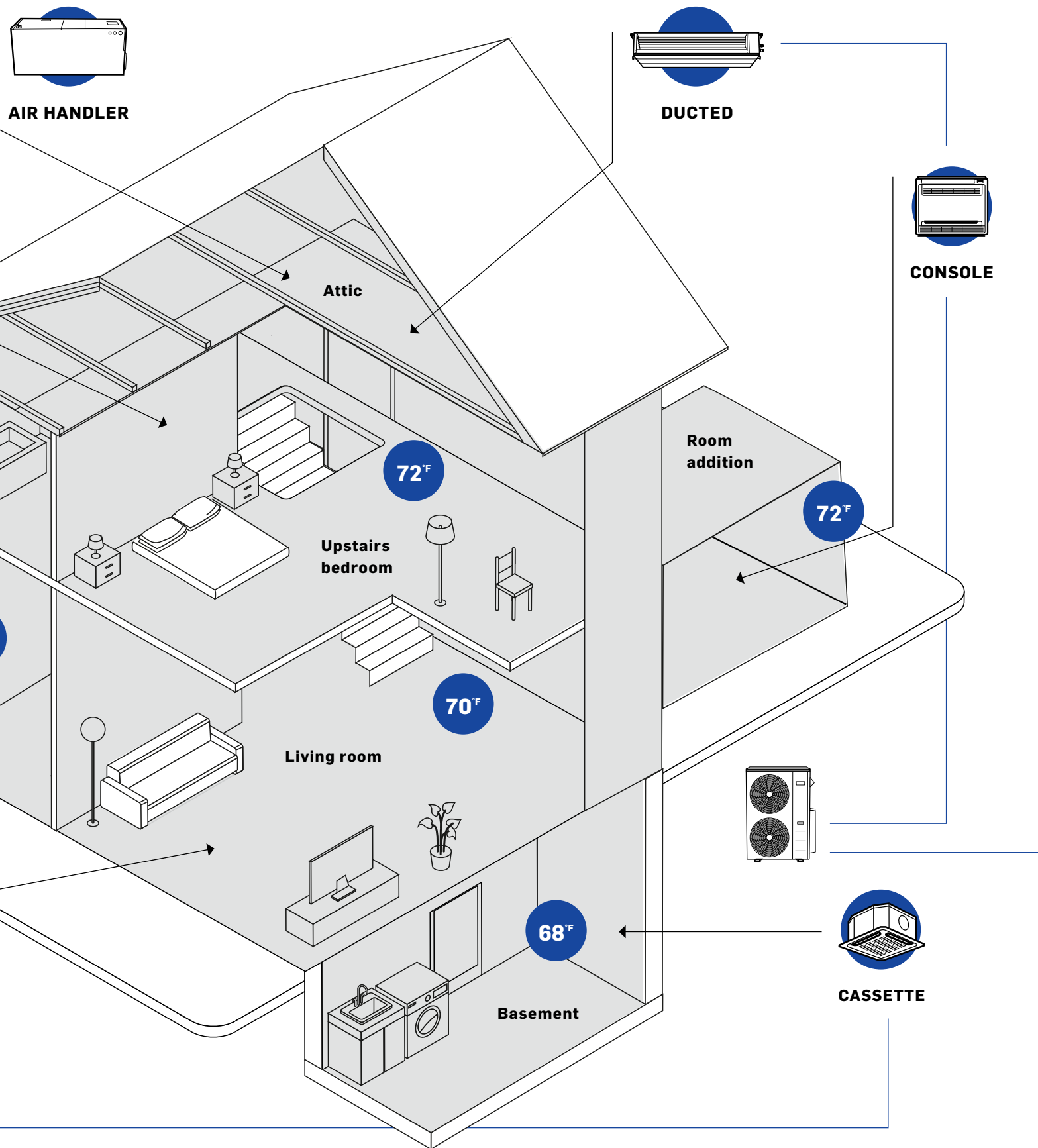

*A BRAND THAT
HAS NEVER
STOPPED
INNOVATING—
& NEVER WILL*



Founded upon Willis Carrier's invention of the modern air conditioning in 1902, Carrier is a world leader in heating, cooling and refrigeration solutions. We are constantly building upon our history of proven innovation with new products and services that improve global comfort and efficiency—addressing customer challenges and providing great experiences along the way.

But our innovation doesn't stop there. From the hiring of the first female air conditioning engineer to the creation of the first air conditioning systems for skyscrapers, homes, factories and ships, Carrier continues to look for ways to advance comfort.

As a trusted partner for precise temperature and humidity control, we know a thing or two about innovation. And it's this same innovation that we put to work in your home. For enhanced in-home comfort, Carrier is the expert you can count on.

"AT THE TIME DUCTLESS PRODUCTS STARTED GETTING POPULAR, WE WERE FORCED TO USE AN INFERIOR BRAND WHICH CAUSED INSTALLATION ISSUES IN THE FIELD AND PLENTY OF WARRANTY CALLS FOR OUR SERVICE DEPARTMENT. WHEN CARRIER CAME OUT WITH ITS DUCTLESS LINE, WE WERE THRILLED! AS A FACTORY AUTHORIZED DEALER FOR CARRIER WE ALREADY KNEW THE QUALITY AND RELIABILITY WOULD BE THERE, AND WE WERE NOT DISAPPOINTED."

Shannon Nielsen, Vice President of Operations, Airplus of California, Inc.

"Fayette Furnace Company has been installing ductless split units for at least the last decade. We started installing these units in homes and businesses that had areas that needed additional cooling. As time progressed and efficiencies improved, the systems became more and more desirable for use throughout the entire home or building for both heating and cooling. Now we are doing very limited ducted attic jobs and increasing ductless split installations, with some applications using the ductless splits as the primary heating and cooling year-round. These systems are ideal for any application."













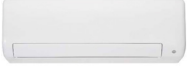

**Michael T. Salanick, Owner/President,
Fayette Furnace Company**



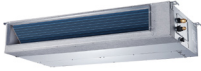











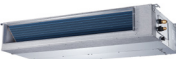

















"Hawaii has a very competitive mini-split/Ductless market. With many different options available, Carrier DLS provides a good product with competitive pricing. Backed by a big name in the industry, given time and good advertising, Carrier DLS/minisplits will be a bigger player in this market."

**Richard Chong, Ductless Dealer &
Innovative, AC Owner**

DUCTLESS & VRF SYSTEMS

Product Lineup

Product Line	Outdoor Units	Indoor Units		
<p>INFINITY SERIES</p> <p>Capacity Range</p> <ul style="list-style-type: none"> • 9–24K Btu/h • Up to 42 SEER • Up to 15 HSPF <p>Pump Type</p> <p>Heat Pump</p>	 <p>Outdoor Unit 38MPRA</p>	 <p>High Wall 40MPHA 9/12K</p>	 <p>High Wall 40MPHA 18/24K</p>	
<p>Performance SERIES</p> <p>Capacity Range</p> <ul style="list-style-type: none"> • 6–36K Btu/h • Up to 28.1 SEER • Up to 13 HSPF <p>Pump Type</p> <p>Heat Pump</p>	 <p>Outdoor Unit 38MARB</p>	 <p>High Wall 40MAHB</p>  <p>Air Handler 40MBAA</p>	 <p>Cassette 40MBCQ</p>  <p>Floor Console 40MBFQ Size 12K</p>	 <p>Ducted 40MBFQ</p>  <p>Console 40MBFQ Size 18–36K</p>  <p>Cased/Uncased Horizontal Fan Coil FMC/FMU</p>  <p>Vertical Fan Coil FMA4X</p>  <p>Fan Coil FV4C</p>
<p>Comfort SERIES</p> <p>Capacity Range</p> <ul style="list-style-type: none"> • 9–24K Btu/h • Up to 19.8 SEER • Up to 10.6 HSPF <p>Pump Type</p> <p>Heat Pump Cooling Only</p>	 <p>Outdoor Unit 38MHRC</p>	 <p>High Wall 40MHH</p>		

Product Line	Outdoor Units	Indoor Units			
<p>Performance <i>SERIES</i></p> <p>Capacity Range</p> <ul style="list-style-type: none"> • 18–48K Btu/h • Up to 23.8 SEER • Up to 10.5 HSPF <p>Pump Type</p> <p>Heat Pump</p>	 <p>Outdoor Unit 38MGR 18K Outdoor Unit 38MGR 24/30K</p>  <p>Outdoor Unit 38MGR 36/48K</p>	 <p>High Wall 40MPHA</p>  <p>High Wall 40MHH</p>	 <p>Ducted 40MBDQ</p>  <p>Console 40MBFQ Size 18/24</p>	 <p>High Wall 40MAHB</p>  <p>Console 40MBFQ Size 12</p>	 <p>Air Handler 40MBAA</p>  <p>Cassette 40MBCQ</p>
<p>INFINITY <i>SERIES</i></p> <p>Capacity Range</p> <ul style="list-style-type: none"> • 36–60K Btu/h • Up to 18.6 SEER • Up to 10 HSPF <p>Pump Type</p> <p>Heat Pump 2-Pipe System</p>	 <p>Outdoor Unit 38VMH</p>	 <p>4-way Compact Cassette</p>  <p>Low Static Ducted (Slim Profile)</p>  <p>Vertical Air Handling Unit (AHU)</p>	 <p>4-way Cassette</p>  <p>Medium Static Ducted</p>  <p>Underceiling</p>	 <p>One-way Compact Cassette</p>  <p>High Wall</p>  <p>Floor Console</p>	
<p>TOSHIBA <i>Carrier</i></p> <p>Capacity Range</p> <ul style="list-style-type: none"> • 72/144K Btu/h • Up to 27.4 IEER • Up to 31.3 SCHE <p>Pump Type</p> <p>Heat Pump 3-Pipe System</p> <hr/> <p>Capacity Range</p> <ul style="list-style-type: none"> • 36–60K Btu/h • Up to 21.5 SEER • Up to 11.5 HSPF <p>Pump Type</p> <p>Heat Pump 2-Pipe System</p>	 <p>Outdoor Unit MMYF</p>  <p>Outdoor Unit MCY7</p>	 <p>4-way Cassette</p>  <p>4-way Compact Cassette</p>  <p>Slim Ducted (Low Profile)</p>  <p>Vertical Air Handling Unit (AHU)</p>	 <p>High Wall</p>  <p>Underceiling</p>  <p>Concealed Ducted (Medium Static)</p>  <p>Outside Air</p>	 <p>Floor Console – Recessed</p>  <p>Floor Console – Exposed</p>  <p>High Static Ducted</p>	

DUCTLESS & VRF SYSTEMS

Product Lineup

Product Line	Outdoor Units	Indoor Units	
<p>TOSHIBA <i>Carrier</i></p> <p>Capacity Range</p> <ul style="list-style-type: none"> • 18–42K Btu/h • Up to 21 SEER • Up to 12 HSPF <p>Pump Type Heat Pump</p>	  Outdoor Unit RAV*AT	 High Wall RAV KRT	 Cassette RAV UT
<p>Performance <i>SERIES</i></p> <p>Capacity Range</p> <ul style="list-style-type: none"> • 36/48/58K Bth/h • Up to 18.0 SEER • Up to 11.5 HSPF <p>Pump Type Heat Pump</p>	 Outdoor Unit 38MBR 58K	 Cassette 40MBCQ	 Console 40MBFQ
	 Outdoor Unit 38MBRB 36/48K	 Air Handler 40MBAA	 Ducted 40MBDQ 36/48K
		 Ducted 40MBDQ 58K	
<p>Performance <i>SERIES</i></p> <p>Capacity Range</p> <ul style="list-style-type: none"> • 18–54K Btu/h • Up to 14 SEER • Up to 8.2 HSPF <p>Pump Type Heat Pump Cooling Only</p>	 Outdoor Units 24AHA4 25HHA4		 Ducted Indoor Units
			



VROOM SELECTION SOFTWARE

With VRoom Selection Software, engineers can easily design, lay out and prepare VRF and DLS systems for quotes.

Features include:

- Auto updates
- Sleek drag-and-drop interface
- Table edit options for quick editing of multiple units
- Quick global edits for wired controllers





SINGLE ZONE

INFINITY® SERIES

38MPRA OUTDOOR UNIT



FEATURES OUTDOOR

- 100% cooling capacity at -22° F (-30° C) without additional kit
- Available in 208/230V
- Built-in basepan heater
- Auto-restart function
- Refrigerant leakage detection
- Quiet outdoor operation, as low as 55 dB(A)
- Anti-corrosive fin coating
- Piping length 98 ft. (30m.)
- Cooling operating range -22° ~ 122° F (-30° ~ 50° C)
- Heating operating range -22° ~ 86° F (-25° ~ 30° C)

COMPATIBLE WITH:

- 40MPHA High Wall (p 24)

INFINITY® SERIES

Infinity®

Heat Pump With Basepan Heater

Heat Pump With Basepan Heater

Inverter Compressor

Up to 42.0 SEER

Up to 15.0 HSPF

Sizes: 09 / 12 / 18 / 24

All Systems are ENERGY STAR® certified



KEY FEATURES

Extra-Low Temperature Heating

Heat output up to 75% of rated capacity down to -22° F (-30° C), so when it's cold outside, it will be warm inside, making this a primary heat source and eliminating the need for a backup heat source.

Stepless Frequency Adjustment

Precise control maintains stable and constant room temperature while reducing sound level and saving energy.



High Wall

SPECIFICATIONS:

38MPRA Outdoor Unit					
Heat Pump System					
Size		9	12	18	24
Outdoor Model		38MPRAQ09AA3	38MPRAQ12AA3	38MPRAQ18AA3	38MPRAQ24AA3
Electrical					
Voltage, Phase, Cycle	V/Ph/Hz	208/230-1-60	208/230-1-60	208/230-1-60	208/230-1-60
MCA	A	13	15	18	20
MOCP - Fuse Rating	A	15	20	30	30
Operating Range					
Cooling Outdoor DB Min - Max	° F (° C)	-22~122 (-30~50)	-22~122 (-30~50)	-22~122 (-30~50)	-22~122 (-30~50)
Heating Outdoor DB Min - Max	° F (° C)	-22~86 (-30~30)	-22~86 (-30~30)	-22~86 (-30~30)	-22~86 (-30~30)
Piping					
Total Piping Length	ft (m)	98 (30)	98 (30)	98 (30)	98 (30)
Piping Lift*	ft (m)	49 (15)	49 (15)	65 (20)	65 (20)
Pipe Connection Size - Liquid	in (mm)	1/4 (6.35)	1/4 (6.35)	3/8" (9.52)	3/8" (9.52)
Pipe Connection Size - Suction	in (mm)	3/8 (9.52)	1/2 (12.7)	5/8" (15.9)	5/8" (15.9)
Refrigerant					
Type		R410A	R410A	R410A	R410A
Charge	lb (kg)	3.5 (1.58)	3.5 (1.58)	5.7 (2.6)	6.5 (2.95)
Compressor					
Type		Rotary Inverter	Rotary Inverter	Rotary Inverter	Rotary Inverter
Outdoor					
Unit Width	in (mm)	33.27 (845)	33.27 (845)	37.24 (946)	37.24 (946)
Unit Height	in (mm)	27.64 (702)	27.64 (702)	31.89 (810)	31.89 (810)
Unit Depth	in (mm)	14.29 (363)	14.29 (363)	16.14 (410)	16.14 (410)
Net Weight	lb (kg)	107.59 (48.8)	108.47 (49.2)	135.4 (61.4)	145.1 (65.8)
Airflow	cfm	1,380	1,380	2,236	2,236
Sound Pressure	dB(A)	55.5	56.0	61.5	62.0

*Condensing unit above or below indoor unit

COMPATIBILITY:

Indoor Unit		Outdoor Unit			
		38MPRAQ09AA3	38MPRAQ12AA3	38MPRAQ18AA3	38MPRAQ24AA3
High Wall	40MPHAQ09XA3	•			
	40MPHAQ12XA3		•		
	40MPHAQ18XA3			•	
	40MPHAQ24XA3				•

High Wall					
Indoor Model		40MPHAQ09XA3	40MPHAQ12XA3	40MPHAQ18XA3	40MPHAQ24XA3
ENERGY STAR®		YES	YES	YES	YES
Cooling System Tons		0.75	1.0	1.5	1.8
Cooling Rated Capacity	Btu/h	9,000	12,000	18,000	22,000
Cooling Cap. Range Min - Max	Btu/h	5,000~17,000	5,800~19,000	6,888~30,511	7,445~32,644
SEER		42.0	32.0	28.2	23.5
EER		15.0	13.5	14.5	13.65
Heating Rated Capacity (47° F)	Btu/h	10,000	12,000	18,000	24,000
Heating Rated Capacity (17° F)	Btu/h	7,200	6,800	12,300	15,450
Heating Max Capacity (17° F)	Btu/h	15,690	17,070	22,000	22,000
Heating Max Capacity (5° F)	Btu/h	13,000	13,800	18,000	24,000
Heating Max Capacity (-13° F)	Btu/h	8,917	9,782	16,572	19,799
Heating Cap. Range Min - Max	Btu/h	3,100~19,100	3,500~21,000	10,835~29,414	12,050~32,270
HSPF		15.0	14.0	14.0	12.0
COP (47° F)	W/W	4.00	4.24	4.12	3.89
COP (17° F)	W/W	2.78	2.64	3.20	3.00
COP (5° F)	W/W	2.00	2.00	2.00	2.00

INFINITY® SERIES 40MPHA HIGH WALL



Infinity® High Wall Indoor Unit

FEATURES

- Available in 208/230V
- Modes: Cool, Heat, Dry, Fan, Auto
- Turbo Mode
- Fully modulating fan speeds
- Sleep Mode
- Up-down/right-left louver control (fixed or swing)
- **Relative Humidity Sensor**
- **Occupancy Sensor** (only sizes 09/12)
- **Wi-Fi® Smartphone Control Built-in**
- ECO Mode
- Carbon Filter
- *Follow Me* (senses temperature at handheld remote)
- Heating Setback (46° F Heating Mode)
- Quiet indoor operation, as low as 29 dB(A)
- Anti-corrosive fin coating

COMPATIBLE WITH:

- 38MPRA Outdoor Unit Single Zone (p 22)
- 38MGR Outdoor Unit Multi-Zone (p 56)

INFINITY® SERIES

Sizes: 09 / 12 / 18 / 24

KEY FEATURES

Relative Humidity Sensor

Increasing comfort customizing the relative humidity in 5% increments in a range of 35% ~ 85%.

Occupancy Sensor

Detects activity in the room and adjusts the horizontal angle of airflow to blow away from people or follow people.

CONTROLS

Wireless Remote Controller included with indoor unit

Wired Remote Controller KSACN0601AAA (7-Day Programmable) (Optional)



**Optional
Wired Controller
(7-Day Programmable)
KSACN0601AAA**



**Wireless
Remote
Controller**

ACCESSORIES

24V Interface for third-party thermostat compatibility KSAIC0301230 (optional)

SPECIFICATIONS:

40MPHA High Wall					
Heat Pump					
System					
Size		9	12	18	24
Indoor Model		40MPHAQ09XA3	40MPHAQ12XA3	40MPHAQ18XA3	40MPHAQ24XA3
Electrical					
Voltage, Phase, Cycle	V/Ph/Hz	208/230-1-60	208/230-1-60	208/230-1-60	208/230-1-60
Power Supply		Indoor unit powered from outdoor unit			
MCA	A	0.3	0.3	0.5	0.5
Controls					
Wireless Remote Controller (° F / ° C Convertible)		Standard	Standard	Standard	Standard
Wired Remote Controller (° F / ° C Convertible)		Optional	Optional	Optional	Optional
Operating Range					
Cooling Indoor DB Min - Max	° F (° C)	62~90 (17~32)	62~90 (17~32)	62~90 (17~32)	62~90 (17~32)
Heating Indoor DB Min - Max	° F (° C)	32~86 (0~30)	32~86 (0~30)	32~86 (0~30)	32~86 (0~30)
Piping					
Pipe Connection Size - Liquid	in (mm)	1/4 (6.35)	1/4 (6.35)	3/8" (9.52)	3/8" (9.52)
Pipe Connection Size - Suction	in (mm)	3/8 (9.52)	1/2 (12.7)	5/8" (15.9)	5/8" (15.9)
Indoor					
Unit Width	in (mm)	35.2 (895)	35.2 (895)	49.57 (1,259)	49.57 (1,259)
Unit Height	in (mm)	11.7 (298)	11.7 (298)	14.25 (362)	14.25 (362)
Unit Depth	in (mm)	9.8 (248)	9.8 (248)	11.10 (282)	11.10 (282)
Net Weight	lb (kg)	37.48 (17)	37.48 (17)	43.4 (19.7)	43.4 (19.7)
Number of Fan Speeds		4	4	4	4
Airflow (lowest to highest)	cfm	144/245/295/345	168/252/306/357	261/389/528/926	359/470/583/926
Sound Pressure (lowest to highest)	dB(A)	29/35.5/41.5/45.6	29/35.5/41.5/46.8	35.1/40.8/46.1/55.9	36.1/43.3/46.4/56.5
Air Throw Data	ft (m)	21.98 (6.7)	22.97 (7)	28.80 (8.7)	31.66 (9.65)
Moisture Removal	Pint/h (L/h)	2.11 (1.0)	2.53 (1.2)	3.8 (1.8)	5.0 (2.39)
Field Drain Pipe Size O.D.	in (mm)	1 (25.4)	1 (25.4)	1 (25.4)	1 (25.4)

Performance may vary based on the compatible outdoor units.

See respective pages for performance data.

COMPATIBILITY:

Indoor Unit	40MPHAQ09XA3	40MPHAQ12XA3	40MPHAQ18XA3	40MPHAQ24XA3
Outdoor Unit Single Zone*	38MPRAQ09AA3	38MPRAQ12AA3	38MPRAQ18AA3	38MPRAQ24AA3
Outdoor Unit Multi-zone*	38MGRQ18B--3 38MGRQ24C--3 38MGRQ30D--3 38MGRQ36D--3 38MGRQ48E--3			

Indoor units sizes 18-24 not compatible with Multi-Zone 38MGR due to size of the indoor unit coil.

PERFORMANCE™ SERIES
38MARB OUTDOOR UNITS



Performance™ Heat Pump with Basepan Heater

FEATURES OUTDOOR

- 100% Heating Capacity at -4° F (-20° C)*
- Available in 208/230V (6-36K) and 115V (12K)
- Built-in basepan heater
- Auto-restart function
- Anti-corrosive fin coating
- Piping Length up to 213 ft (65m)
- Cooling operating range -22° ~ 130° F (-30° ~ 55° C)
- Heating operating range -22° ~ 86° F (-25° ~ 30° C)

COMPATIBLE WITH

- 40MAHB High Wall (p 30)
- 40MBCQ Cassette (p 32)
- 40MBDQ Ducted (p 34)
- 40MBFQ Console (p 38)
- FMA4X Fan Coil
- FMC-FMU Fan Coil
- FV4C Fan Coil
- FX4D Fan Coil
- FB4C Fan Coil
- 40MBAA Air Handler (p 36)

Performance
SERIES

Heat Pump With Basepan Heater

Inverter Compressor

Up to 28.1 SEER

Up to 13.0 HSPF

Sizes: 06 / 09 / 12 / 18 / 24 / 30 / 36 (208-230V); Size 12 (115V)



Select sizes are ENERGY STAR® certified based on indoor unit pairing

KEY FEATURES

Extra-Low Temperature Heating

Heat output up to 69% of rated capacity at -22° F (-30° C). So, when it's cold outside, it will be warm inside, making this a primary heat source and eliminating the need for a backup.

Rapid Cooling and Heating

After startup, the compressor quickly gets up to maximum speed, cooling or heating the room in minutes.



High Wall



**Cassette
Sizes 09 / 12 / 18**



**Cassette
Size 24**

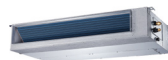

Ducted



**Floor Console
Size 12**



**Console
Sizes 18 / 24**



**Vertical Fan
Coil
FMA4X**



**Horizontal Fan
Coil
FMC/FMU**



**Fan Coil
FV4C, FX4D,
FB4C**



**Air Handler
Size 24**

* For certain models.

PERFORMANCE™ SERIES 38MARB OUTDOOR UNITS

PERFORMANCE:

40MAHB High Wall																
Size	12		6		9		12		18		24		30		36	
Indoor Model	40MAHBQ12XA1		40MAHBQ06XA3		40MAHBQ09XA3		40MAHBQ12XA3		40MAHBQ18XA3		40MAHBQ24XA3		40MAHBQ30XA3		40MAHBQ36XA3	
ENERGY STAR®	YES		YES		YES		YES		YES		YES		NO		NO	
Cooling Rated Capacity	Btu/h	12,000	6,000	9,000	12,000	18,000	24,000	30,000	36,000							
Cooling Cap. Range Min - Max	Btu/h	3,500~13,200	2,500~11,000	3,300~13,400	3,300~14,300	8,870~19,400	6,850~2,700	9,070~30,700	9,300~38,800							
SEER		23.0	26.5	28.1	25.5	21.5	21.5	20.0	17.5							
EER		13.0	15.8	16.2	14	12.5	13.0	11.5	8.5							
Heating Rated Capacity (47° F)	Btu/h	12,100	7,400	11,800	12,000	18,000	29,000	30,000	36,000							
Heating Rated Capacity (17° F)	Btu/h	7,400	4,900	7,500	7,500	10,800	19,800	19,000	22,400							
Heating Maximum Capacity (17° F)	Btu/h	12,200	9,000	12,000	12,000	14,000	24,480	20,670	23,600							
Heating Maximum Capacity (5° F)	Btu/h	7,100	7,500	10,500	11,650	18,000	25,400	17,200	20,400							
Heating Cap. Range Min - Max	Btu/h	5,000~12,200	3,500~11,600	5,000~15,200	5,000~15,300	8,400~19,500	8,600~31,000	8,600~34,800	11,570~37,000							
HSPF		11.5	14.0	13.0	13.0	13.0	12.0	9.6	9.0							
COP (47° F)	W/W	3.70	3.90	3.81	3.81	3.10	3.40	2.60	2.51							
COP (17° F)	W/W	2.67	3.05	3.00	3.00	2.80	3.05	2.25	2.18							
COP (5° F)	W/W	2.18	1.90	1.80	1.80	1.80	1.80	1.75	1.75							

PERFORMANCE:

40MBCQ Cassette									
Size	9		12		18		24		
Indoor Model	40MBCQ09---3		40MBCQ12---3		40MBCQ18---3		40MBCQ24---3		
ENERGY STAR®	YES		YES		YES		NO		
Cooling System Tons		0.75	1.00	1.33	2.00				
Cooling Rated Capacity	Btu/h	9,000	12,000	16,000	24,000				
Cooling Cap. Range Min - Max	Btu/h	2,850~11,100	3,000~13,700	5,600~17,000	8,000~25,000				
SEER		20.5	21.5	20.0	20.0				
EER		13.0	12.7	12.5	11.0				
Heating Rated Capacity (47° F)	Btu/h	10,000	12,000	18,000	24,000				
Heating Rated Capacity (17° F)	Btu/h	6,650	8,250	11,200	15,100				
Heating Maximum Capacity (17° F)	Btu/h	11,800	14,000	21,000	24,200				
Heating Maximum Capacity (5° F)	Btu/h	9,800	11,500	16,300	23,600				
Heating Cap. Range Min - Max	Btu/h	1,800~12,500	2,000~15,300	8,700~21,000	11,840~27,000				
HSPF		10.8	10.6	10.3	11.6				
COP (47° F)	W/W	2.93	3.22	2.88	3.50				
COP (17° F)	W/W	1.80	2.20	1.80	2.70				
COP (5° F)	W/W	1.80	1.86	1.80	1.80				

PERFORMANCE:

40MBDQ Ducted									
Size	9		12		18		24		
Indoor Model	40MBDQ09---3		40MBDQ12---3		40MBDQ18---3		40MBDQ24---3		
ENERGY STAR®	YES		YES		YES		YES		
Cooling System Tons		0.75	1.0	1.4	2.0				
Cooling Rated Capacity	Btu/h	9,000	12,000	16,500	24,000				
Cooling Cap. Range Min - Max	Btu/h	2,400~12,500	2,250~14,400	6,500~18,800	6,500~27,800				
SEER		23.0	21.5	19.6	20.6				
EER		14.0	13.0	12.5	12.5				
Heating Rated Capacity (47° F)	Btu/h	10,000	12,000	19,000	24,600				
Heating Rated Capacity (17° F)	Btu/h	6,450	8,350	12,700	16,500				
Heating Maximum Capacity (17° F)	Btu/h	11,600	12,900	21,500	26,500				
Heating Maximum Capacity (5° F)	Btu/h	9,500	12,400	17,300	24,600				
Heating Cap. Range Min - Max	Btu/h	1,700~15,600	1,800~16,300	8,900~22,000	12,200~32,200				
HSPF		12.0	11.5	11.0	12.6				
COP (47° F)	W/W	3.62	3.52	2.93	3.66				
COP (17° F)	W/W	1.90	2.00	1.90	2.80				
COP (5° F)	W/W	1.80	1.87	1.80	2.01				

PERFORMANCE™ SERIES 38MARB OUTDOOR UNITS

PERFORMANCE:

40MBFQ Console				
Size		12	18	24
Indoor Model		40MBFQ12---3	40MBFQ18---3	40MBFQ24---3
ENERGY STAR®		YES	YES	NO
Cooling System Tons		1.0	1.4	2.0
Cooling Rated Capacity	Btu/h	12,000	17,000	24,000
Cooling Cap. Range Min - Max	Btu/h	2,800~13,500	7,800~19,900	9,000~26,800
SEER		23.0	20.2	20.2
EER		13.0	12.5	11.5
Heating Rated Capacity (47° F)	Btu/h	12,000	18,000	24,600
Heating Rated Capacity (17° F)	Btu/h	8,400	12,000	15,240
Heating Maximum Capacity (17° F)	Btu/h	13,100	20,700	26,661
Heating Maximum Capacity (5° F)	Btu/h	12,100	16,400	23,600
Heating Cap. Range Min - Max	Btu/h	2,350~15,700	8,600~21,500	12,500~30,500
HSPF		11.5	10.6	11.6
COP (47° F)	W/W	3.22	3.19	3.52
COP (17° F)	W/W	2	1.8	2.7
COP (5° F)	W/W	1.84	1.80	1.80

40MBAA Air Handler		
Size		24
Indoor Model		40MBAAQ24XA3
ENERGY STAR®		YES
Cooling System Tons		1.80
Cooling Rated Capacity	Btu/h	22,000
Cooling Cap. Range Min - Max	Btu/h	7,500~26,000
SEER		20.0
EER		12.5
Heating Rated Capacity (47° F)	Btu/h	27,000
Heating Rated Capacity (17° F)	Btu/h	16,500
Heating Maximum Capacity (17° F)	Btu/h	25,000
Heating Maximum Capacity (5° F)	Btu/h	21,500
Heating Cap. Range Min - Max	Btu/h	5,600~31,000
HSPF		11.6
COP (47° F)	W/W	3.77
COP (17° F)	W/W	2.60
COP (5° F)	W/W	1.80

SPECIFICATIONS:

38MARB Outdoor Unit										
Heat Pump										
System										
Size		12	6	9	12	18	24	30	36	
Outdoor Model		38MARBQ12AA1	38MARBQ06AA3	38MARBQ09AA3	38MARBQ12AA3	38MARBQ18AA3	38MARBQ24AA3	38MARBQ30AA3	38MARBQ36AA3	
Electrical										
Voltage-Phase-Cycle	V-Ph-Hz	115-1-60	208/230-1-60	208/230-1-60	208/230-1-60	208/230-1-60	208/230-1-60	208/230-1-60	208/230-1-60	208/230-1-60
MCA	A.	19	13	15	15	16	25	23	28	
MOCP - Fuse Rating	A.	25	15	15	15	25	35	30	35	
Operating Range										
Cooling Outdoor DB Min - Max	° F (° C)	-22~122 (-30~50)	-22~122 (-30~50)	-22~122 (-30~50)	-22~122 (-30~50)	-22~122 (-30~50)	-22~122 (-30~50)	-22~122 (-30~50)	-22~122 (-30~50)	-22~122 (-30~50)
Heating Outdoor DB Min - Max	° F (° C)	-22~86 (-30~30)	-22~86 (-30~30)	-22~86 (-30~30)	-22~86 (-30~30)	-22~86 (-30~30)	-22~86 (-30~30)	-22~86 (-30~30)	-22~86 (-30~30)	-22~86 (-30~30)
Piping										
Total Piping Length	ft (m)	82 (25)	82 (25)	82 (25)	82 (25)	98 (30)	164 (50)	164 (50)	213 (65)	
Piping Lift*	ft (m)	32 (10)	32 (10)	32 (10)	32 (10)	65 (20)	82 (25)	82 (25)	98 (30)	
Pipe Connection Size - Liquid	in (mm)	1/4 (6.35)	1/4 (6.35)	1/4 (6.35)	1/4 (6.35)	1/4 (6.35)	3/8 (9.52)	3/8 (9.52)	3/8 (9.52)	
Pipe Connection Size - Suction	in (mm)	1/2 (12.7)	3/8 (9.52)	3/8 (9.52)	1/2 (12.7)	1/2 (12.7)	5/8 (16)	5/8 (16)	5/8 (16)	
Refrigerant										
Type		R410A	R410A	R410A	R410A	R410A	R410A	R410A	R410A	
Charge	in (mm)	2.47 (1.12)	2.38 (1.08)	2.6 (1.18)	2.6 (1.18)	4.08 (1.85)	5.73 (2.6)	6.06 (2.75)	7.50 (3.40)	
Compressor										
Type		Rotary Inverter	Rotary Inverter	Rotary Inverter	Rotary Inverter	Rotary Inverter	Rotary Inverter	Rotary Inverter	Rotary Inverter	
Outdoor										
Unit Width	in (mm)	30.12 (765)	30.12 (765)	31.69 (805)	31.69 (805)	35.04 (890)	37.24 (946)	37.24 (946)	37.24 (946)	
Unit Height	in (mm)	24.02 (610)	21.85 (555)	24.21 (615)	24.21 (615)	29.13 (740)	34.84 (885)	34.84 (885)	34.84 (885)	
Unit Depth	in (mm)	11.93 (303)	11.93 (303)	12.99 (330)	12.99 (330)	13.46 (342)	16.14 (410)	16.14 (410)	16.14 (410)	
Net Weight	lbs (kg)	66.80 (30.3)	63.71 (28.9)	74.07 (33.6)	73.63 (33.4)	100.97 (45.8)	134.48 (61)	141.76 (64.3)	150.13 (68.1)	
Airflow	CFM	794	1,324	1,324	1,324	1,765	2,235	2,235	2,235	
Sound Pressure	dB(A)	54.0	54.5	54.5	56.0	59.0	62.0	61.5	61.5	

*Condensing unit above or below indoor unit.

COMPATIBILITY:

Indoor Unit		Outdoor Unit							
		38MAQB12R--1		38MAQB09R--3	38MAQB12R--3	38MAQB18R--3	38MAQB24R--3	38MAQB30R--3	38MAQB36R--3
		38MARBQ12AA1	38MARBQ06AA3	38MARBQ09AA3	38MARBQ12AA3	38MARBQ18AA3	38MARBQ24AA3	38MARBQ30AA3	38MARBQ36AA3
40MAHB High Wall	40MAHBQ12XA1	•							
	40MAHBQ06XA3		•						
	40MAHBQ09XA3			•					
	40MAHBQ12XA3				•				
	40MAHBQ18XA3					•			
	40MAHBQ24XA3						•		
	40MAHBQ30XA3							•	
40MBCQ Cassette*	40MBCQ09---3			•					
	40MBCQ12---3				•				
	40MBCQ18---3					•			
	40MBCQ24---3						•		
	40MBCQ36---3								
	40MBCQ48---3								
40MBDQ Ducted*	40MBDQ09---3			•					
	40MBDQ12---3				•				
	40MBDQ18---3					•			
	40MBDQ24---3						•		
	40MBDQ36---3								
	40MBDQ48---3								
	40MBDQ58---3								
40MBFQ Console*	40MBFQ12---3				•				
	40MBFQ18---3					•			
	40MBFQ24---3						•		
	40MBFQ36---3								
	40MBFQ48---3								
	40MBFQ58---3								

*Cassette, Ducted and Console indoor units sizes 36, 48 & 58 ONLY compatible with 38MBR or 38MBRB Outdoor Unit.

- Not available/compatible or Phased out
- Compatible

PERFORMANCE™ SERIES

40MAHB HIGH WALL



Performance™ High Wall Indoor Unit

FEATURES

- Available in 208/230V (6-36K) or 115V (12K)
- Modes: Cool, Heat, Dry, Fan, Auto
- Turbo Mode
- Fully Modulating fan speeds
- Sleep Mode
- Up-Down / Left-Right Louver control (fixed or swing)
- Relative Humidity Sensor with percentage and temperature control
- Intelligent Eye (Occupancy Sensor)
- ECO Mode
- Heating Setback (46° F Heating Mode)
- Anti-corrosive fin coating

COMPATIBLE WITH:

- 38MARB Outdoor Unit Single Zone (p 26)
- 38MGR Outdoor Unit Multi-zone (p 56)

Performance™
SERIES

Sizes: 06 / 09 / 12 / 18 / 24 / 30 / 36
(208-230V); Size 12 (115V)

Up to 28.1 SEER

Up to 13.0 HSPF

KEY FEATURES

Time-saving Design

The unit disassembles quickly with a removable filter on top for simplified maintenance. The motor and blower can be serviced without removing the cabinet.

Improved Efficiency & Performance

ECO mode with intelligent eight-hour night cycle program saves up to 60% of energy for improved overnight comfort, efficiency and performance.

Customizable Comfort

Compatible with both single and multi-zone outdoor units for maximum flexibility.

CONTROLS

Wireless Remote Controller included with indoor unit

Optional Wired Remote Controller KSACN0801AAA
(7-Day Programmable)



**Wireless
Remote Controller**



**Wired Controller
(7-Day Programmable)
KSACN0801AAA**

ACCESSORIES

Wi-Fi® Kit KSAIF0601AAA

24V Interface for third-party thermostat compatibility KSAIC0301230

SPECIFICATIONS:

40MAHB High Wall									
Heat Pump									
System									
Size		12	6	9	12	18	24	30	36
Indoor Model		40MAHBQ12XA1	40MAHBQ06XA3	40MAHBQ09XA3	40MAHBQ12XA3	40MAHBQ18XA3	40MAHBQ24XA3	40MAHBQ30XA3	40MAHBQ36XA3
Electrical									
Voltage-Phase-Cycle	V-Ph-Hz	115-1-60	208/230-1-60	208/230-1-60	208/230-1-60	208/230-1-60	208/230-1-60	208/230-1-60	208/230-1-60
Power Supply		Indoor unit powered from outdoor unit							
MCA	A.	0.2500	0.3125	0.3125	0.3125	0.1625	0.6250	0.6250	0.6250
Controls									
Wireless Remote Controller (° F/° C Convertible)		Standard	Standard	Standard	Standard	Standard	Standard	Standard	Standard
Wired Remote Controller (° F/° C Convertible)		Optional	Optional	Optional	Optional	Optional	Optional	Optional	Optional
24V Interface for 3rd Party Thermostat Control		Optional	Optional	Optional	Optional	Optional	Optional	Optional	Optional
Wi-Fi® Control for Phone App Control		Optional	Optional	Optional	Optional	Optional	Optional	Optional	Optional
Operating Range									
Cooling Outdoor DB Min - Max	° F (° C)	63~90 (17~32)	63~90 (17~32)	63~90 (17~32)	63~90 (17~32)	63~90 (17~32)	63~90 (17~32)	63~90 (17~32)	63~90 (17~32)
Heating Outdoor DB Min - Max	° F (° C)	32~86 (0~30)	32~86 (0~30)	32~86 (0~30)	32~86 (0~30)	32~86 (0~30)	32~86 (0~30)	32~86 (0~30)	32~86 (0~30)
Piping									
Pipe Connection Size - Liquid	in (mm)	1/4 (6.35)	1/4 (6.35)	1/4 (6.35)	1/4 (6.35)	1/4 (6.35)	3/8 (9.52)	3/8 (9.52)	3/8 (9.52)
Pipe Connection Size - Suction	in (mm)	1/2 (12.7)	3/8 (9.52)	3/8 (9.52)	1/2 (12.7)	1/2 (12.7)	5/8 (16)	5/8 (16)	5/8 (16)
Indoor Coil									
Face Area	Sq. Ft.	2.15	2.15	2.15	2.15	2.75	3.60	3.60	3.60
No. Rows		2	2	2	2	2	3	3	3
Fins per inch		20	20	20	20	20	20	20	20
Circuits		3	3	3	3	4	7	7	7
Indoor									
Unit Width	in (mm)	31.3 (795)	31.3 (795)	31.3 (795)	31.3 (795)	37.99 (965)	44.88 (1140)	44.88 (1140)	44.88 (1140)
Unit Height	in (mm)	11.61 (295)	11.61 (295)	11.61 (295)	11.61 (295)	12.56 (319)	14.57 (370)	14.57 (370)	14.57 (370)
Unit Depth	in (mm)	8.86 (225)	8.86 (225)	8.86 (225)	8.86 (225)	9.41 (239)	10.83 (275)	10.83 (275)	10.83 (275)
Net Weight	lbs (kg)	22.93 (10.4)	22.71 (10.3)	22.71 (10.3)	22.93 (10.4)	27.12 (12.3)	43.65 (19.8)	43.65 (19.8)	43.65 (19.8)
Number of Fan Speeds		4	4	4	4	4	4	4	4
Airflow (lowest to highest)	CFM	235/294/353/412	176/229/335/382	176/229/335/382	176/229/335/382	306/376/524/635	319/414/611/719	382/505/646/843	382/506/639/843
Sound Pressure (lowest to highest)	dB(A)	24/30/41/47	32/34/38/47	32/34/38/47	30/32/37/47	37/40/46/48	37/39/44/52	38/41/46/52	39/41/46/52
Air Throw Data	ft (m)	27.9 (8.5)		24.9 (7.6)	26.2 (8.0)	27.9 (8.5)	31.5 (9.6)	33.8 (10.3)	33.8 (10.3)
Moisture Removal	Pint/h (L/h)	0.048 (0.023)		0.015 (0.007)	0.046 (0.022)	0.091 (0.044)	0.108 (0.052)	0.154 (0.074)	0.240 (0.115)
Field Drain Pipe Size O.D.	in (mm)	0.625 (16)	0.625 (16)	0.625 (16)	0.625 (16)	0.625 (16)	0.625 (16)	0.625 (16)	0.625 (16)

COMPATIBILITY:

Indoor Unit	40MAHBQ12XA1	40MAHBQ06XA3	40MAHBQ09XA3	40MAHBQ12XA3	40MAHBQ18XA3	40MAHBQ24XA3	40MAHBQ30XA3	40MAHBQ36XA3
Outdoor Unit Single Zone*	38MARBQ12AA1	38MARBQ06AA3	38MARBQ09AA3	38MARBQ12AA3	38MARBQ18AA3	38MARBQ24AA3	38MARBQ30AA3	38MARBQ36AA3
Outdoor Unit Multi-Zone*		38MGRQ18B--3						
		38MGRQ24C--3						
		38MGRQ30D--3						
		38MGRQ36D--3						
		38MGRQ48E--3						

*Performance may vary based on the compatible outdoor units. See respective pages for performance data.

PERFORMANCE™ SERIES 40MBCQ CASSETTE



Performance™ Cassette Indoor Unit

FEATURES

- Modes: Cool, Heat, Dry, Fan, Auto
- Auto-restart function
- Louver control (fixed or swing)
- Three fan speeds
- Outside air intake
- Built-in condensate lift pump
- *Follow Me* (senses temperature at handheld remote)
- Heating Setback (46° F Heating Mode)
- Quiet indoor operation, as low as 34 dB(A)
- Anti-corrosive fin coating
- Grille/ceiling panel 2" x 2" sizes 9 to 18 40MBCQ01XXX3
- Grille/ceiling panel 3" x 3" size 24 P/N 40MBCQ02XXX3

COMPATIBLE WITH:

- 38MARB Outdoor Unit Single Zone (p 26)
- 38MGR Outdoor Unit Multi-zone (p 56)

Performance
SERIES

Sizes: 09 / 12 / 18 / 24

KEY FEATURES

Built-in Condensate Lift Pump

The cassette is supplied with a condensate lift pump that is capable of lifting the water 29.5in. (750mm.) above the top of the unit.

Integrated Electrical Components

Easy maintenance with the circuit box right inside the unit. The integrated design provides a more compact size for easier installation.

CONTROLS

Wireless Remote Controller included with indoor unit

Optional Wired Remote Controller KSACN0101AAA (Timer Function)

Optional Wired Remote Controller KSACN0701AAA (7-Day Programmable)



**Optional
Wired Controller
(Timer Function)
KSACN0101AAA**



**Optional
Wired Controller
(7-Day Programmable)
KSACN0701AAA**



**Wireless
Remote
Controller**

ACCESSORIES

Wi-Fi® Smartphone control kit KSAIF0401AAA

24V Interface for compatibility with conventional thermostat KSAIC0301230

Grille is required; sold separately.

SPECIFICATIONS:

40MBCQ Cassette					
Heat Pump					
System					
Size		9	12	18	24
Indoor Model		40MBCQ09---3	40MBCQ12---3	40MBCQ18---3	40MBCQ24---3
Electrical					
Voltage, Phase, Cycle	V/Ph/Hz	208/230-1-60	208/230-1-60	208/230-1-60	208/230-1-60
Power Supply		Indoor Unit Powered From Outdoor Unit			
MCA	A	0.2	0.2	0.2	0.3
Controls					
Wireless Remote Controller (° F / ° C Convertible)		Standard	Standard	Standard	Standard
Wired Remote Controller (° F / ° C Convertible)		Optional	Optional	Optional	Optional
Operating Range					
Cooling Indoor DB Min - Max	° F (° C)	63~90 (17~32)	63~90 (17~32)	63~90 (17~32)	62~90 (17~32)
Heating Indoor DB Min - Max	° F (° C)	32~86 (0~30)	32~86 (0~30)	32~86 (0~30)	32~86 (0~30)
Piping					
Pipe Connection Size - Liquid	in (mm)	1/4 (6.35)	1/4 (6.35)	1/4 (6.35)	3/8 (9.52)
Pipe Connection Size - Suction	in (mm)	3/8 (9.52)	1/2 (12.7)	1/2 (12.7)	5/8 (16)
Indoor					
Body Unit Width	in (mm)	22.44 (570)	22.44 (570)	22.44 (570)	33.07 (840)
Body Unit Height	in (mm)	10.24 (260)	10.24 (260)	10.24 (260)	8.07 (205)
Body Unit Depth	in (mm)	22.44 (570)	22.44 (570)	22.44 (570)	33.07 (840)
Body Net Weight	lb (kg)	35.27 (16)	35.27 (16)	39.68 (18)	46.3 (21)
Panel Unit Width	in (mm)	25.47 (647)	25.47 (647)	25.47 (647)	37.4 (950)
Panel Unit Height	in (mm)	1.97 (50)	1.97 (50)	1.97 (50)	2.17 (55)
Panel Unit Depth	in (mm)	25.47 (647)	25.47 (647)	25.47 (647)	37.4 (950)
Panel Net Weight	lb (kg)	5.51 (2.5)	5.51 (2.5)	5.51 (2.5)	11.02 (5)
Number of Fan Speeds		3	3	3	3
Airflow (lowest to highest)	cfm	260/320/380	280/340/400	290/350/420	625/761/878
Sound Pressure (lowest to highest)	dB(A)	34/39/44	36/39/42	46/48/50	47/50/52
Air Throw Data	ft (m)	23 (7)	23 (7)	30 (9)	30 (9)
Moisture Removal	Pint/h (L/h)	1.58 (0.75)	2.88 (1.366)	4.26 (2.02)	5.22 (2.47)
Field Drain Pipe Size O.D.	in (mm)	1 (25.4)	1 (25.4)	1 (25.4)	1 (25.4)

Performance may vary based on the compatible outdoor units. See respective pages for performance data.

COMPATIBILITY:

Indoor Unit	40MBCQ09---3	40MBCQ12---3	40MBCQ18---3	40MBCQ24---3
Outdoor Unit Single Zone	38MARBQ09AA3	38MARBQ12AA3	38MARBQ18AA3	38MARBQ24AA3
Outdoor Unit Multi-Zone	38MGRQ18B--3			
	38MGRQ24C--3			
			38MGRQ30D--3	
			38MGRQ36D--3	
			38MGRQ48E--3	

Backward compatible with 38MAQ Single Zone and 38MGQ Multi-Zone Systems

PERFORMANCE™ SERIES

40MBDQ DUCTED

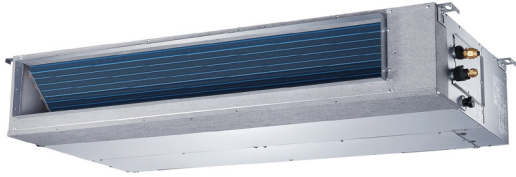

Performance™ Ducted Indoor Unit

FEATURES

- Modes: Cool, Heat, Dry, Fan, Auto
- Vertical or horizontal installation
- Up to 0.64 in W.C.
- Rear or bottom return
- Outside air intake
- *Follow Me* (senses temperature at handheld remote)
- Heating Setback (46°F Heating Mode)
- Quiet indoor operation, as low as 30 dB(A)
- Anti-corrosive fin coating
- External condensate lift pump shipped with the unit (sizes 09-18)
- Built-in condensate lift pump (size 24)

COMPATIBLE WITH:

- 38MARB Outdoor Unit Single Zone (p 26)
- 38MGR Outdoor Unit Multi-Zone (p 56)

Performance
SERIES

Sizes: 09 / 12 / 18 / 24

KEY FEATURES

Vertical or Horizontal Installation

Designed for maximum installation flexibility. The secondary drain built-in allows the unit to be mounted vertically allowing either a floor or ceiling-concealed installation depending on existing conditions.

Flexible Air Intake

Air inlet can be installed either at the back or the bottom of the unit due to the small plate size on the flange, allowing for flexible installation to meet the needs of each job.

CONTROLS

Wireless Remote Controller included with indoor unit

Optional Wired Remote Controller (Timer Function)

Wired Remote Controller KSACN0701AAA (7-Day Programmable) included with indoor unit



**Optional
Wired Controller
(Timer Function)
KSACN0101AAA**



**Wired Controller
(7-Day Programmable)
KSACN0701AAA**



**Wireless
Remote
Controller**

ACCESSORIES

Wi-Fi® Smartphone control kit KSAIF0401AAA

24V Interface for compatibility with conventional thermostat KSAIC0301230

SPECIFICATIONS:

40MBDQ Ducted					
Heat Pump					
System					
Size		9	12	18	24
Indoor Model		40MBDQ09---3	40MBDQ12---3	40MBDQ18---3	40MBDQ24---3
Electrical					
Voltage, Phase, Cycle	V/Ph/Hz	208/230-1-60	208/230-1-60	208/230-1-60	208/230-1-60
Power Supply		Indoor Unit Powered From Outdoor Unit			
MCA	A	1.11	1.11	1.2	1.2
Controls					
Wireless Remote Controller (° F / ° C Convertible)		Standard	Standard	Standard	Standard
Wired Remote Controller (° F / ° C Convertible)		Standard	Standard	Standard	Standard
Operating Range					
Cooling Indoor DB Min - Max	° F (° C)	63~90 (17~32)	63~90 (17~32)	63~90 (17~32)	63~90 (17~32)
Heating Indoor DB Min - Max	° F (° C)	32~86 (0~30)	32~86 (0~30)	32~86 (0~30)	32~86 (0~30)
Piping					
Pipe Connection Size - Liquid	in (mm)	1/4 (6.35)	1/4 (6.35)	1/4 (6.35)	3/8 (9.52)
Pipe Connection Size - Suction	in (mm)	3/8 (9.52)	1/2 (12.7)	1/2 (12.7)	5/8 (16)
Indoor					
Unit Width	in (mm)	27.56 (700)	27.56 (700)	34.65 (880)	43.31 (1100)
Unit Height	in (mm)	7.87 (200)	7.87 (200)	8.27 (210)	9.8 (249)
Unit Depth	in (mm)	19.92 (506)	19.92 (506)	26.54 (674)	30.47 (774)
Net Weight	lb (kg)	43.56 (19.8)	43.56 (19.8)	54 (24.5)	86.86 (39.4)
Number of Fan Speeds		3	3	3	3
Airflow (lowest to highest)	cfm	147/211/264	176/282/353	300/400/480	440/700/780
Sound Pressure (lowest to highest)	dB(A)	30/34/38	35/37/39	35/37/39	35.5/40/44
Max Static Pressure	in W.C.	0.20	0.20	0.40	0.64
Field Drain Pipe Size O.D.	in (mm)	1 (25.4)	1 (25.4)	1 (25.4)	1 (25.4)

Performance may vary based on the compatible outdoor units. See respective pages for performance data.

COMPATIBILITY:

Indoor Unit	40MBDQ09---3	40MBDQ12---3	40MBDQ18---3	40MBDQ24---3
Outdoor Unit Single Zone	38MARBQ09AA3	38MARBQ12AA3	38MARBQ18AA3	38MARBQ24AA3
Outdoor Unit Multi-Zone	38MGRQ18B--3			
	38MGRQ24C--3			
	38MGRQ30D--3			
	38MGRQ36D--3			
	38MGRQ48E--3			

For Sizes 36 and 48, refer to the Light Commercial Section

Backward compatible with 38MAQ Single Zone and 38MGQ Multi-Zone Systems

PERFORMANCE™ SERIES 40MBAA AIR HANDLER



Performance™ Multi-Poise Air Handler

FEATURES

- Modes: Cool, Heat, Dry, Fan, Auto
- Up to 20.0 SEER and 10.4 HSPF based on outdoor unit pairing
- Multi Poise Installation (Up Flow, Down Flow, Horizontal Right, Horizontal Left)
- Total system static pressure up to 0.8 in. W.C.
- Less than 2% air leakage
- Quiet indoor operation
- Built-in third-party thermostat compatibility
- Anti-corrosive fin coating
- Extreme heating operation in as low as -22° F (-30° C) based on outdoor unit pairing
- Optional Electric Heat Packages available (5,10,15 and 20 KW)
- Powered from the outdoor unit

COMPATIBLE WITH:

- 38MARB Outdoor Unit Single Zone (p 26)
- 38MGR Outdoor Unit Multi-Zone (p 56)
- 38MBRB Outdoor Unit Single Zone (p 64)

Performance
SERIES

Size: 24 / 36 / 48

Select sizes are ENERGY STAR® certified based on outdoor unit pairing

KEY FEATURES

Installation Flexibility

A built-in secondary drain allows the unit to be mounted vertically (up flow or down flow) or horizontally (left or right), enabling multi-position installation. All three sizes are capable of operating as traditional central ducted systems when paired with a compatible single zone outdoor unit.

Multi-Zone Compatibility

The size 24 Air Handler can connect to select multi-zone outdoor units to create one integrated system, enabling unique zoned comfort and efficiency.

Efficient Comfort

As an alternate to gas furnaces, reduce the use of fossil fuels and experience cleaner energy and efficiency levels that meet many local and federal requirements.

CONTROLS

Factory installed 24V interface for third-party thermostat compatibility*

Wireless Remote Controller included

ACCESSORIES

Electric Heat Packages EHKMA05KN, EHKMA10KN, EHKMA15KN, EHKMA20KN

Only Size 24 is available for multi-zone applications.

*Note: See installation instructions for details

SPECIFICATIONS:

40MBAA Air Handler				
Heat Pump				
System				
Size		24	36	48
Indoor Model		40MBAAQ24XA3	40MBAAQ36XA3	40MBAAQ48XA3
Electrical				
Voltage-Phase-Cycle	V-Ph-Hz	208/230-1-60	208/230-1-60	208/230-1-60
Power Supply		Indoor Unit Powered From Outdoor Unit		
MCA	A.	5	5	5
Controls				
Wireless Remote Controller (° F/° C Convertible)		Standard	Standard	Standard
Third party thermostat compatibility		Standard	Standard	Standard
Operating Range				
Cooling Indoor DB Min - Max	° F (° C)	62~90 (17~32)	62~90 (17~32)	62~90 (17~32)
Heating Indoor DB Min - Max	° F (° C)	32~86 (0~30)	32~86 (0~30)	32~86 (0~30)
Piping				
Pipe Connection Size - Liquid	in (mm)	3/8 (9.52)	3/8 (9.52)	3/8 (9.52)
Pipe Connection Size - Suction	in (mm)	5/8 (16)	5/8 (16)	5/8 (16)
Indoor				
Unit Width	in (mm)	19.6 (498)	19.6 (498)	19.6 (498)
Unit Height	in (mm)	48.8 (1,240)	48.8 (1,240)	48.8 (1,240)
Unit Depth	in (mm)	21.0 (533)	21.0 (533)	21.0 (533)
Net Weight	lbs (kg)	141.1 (64)	144.8 (65.7)	144.8 (65.7)
Number of Fan Speeds		4	4	4
Airflow (lowest to highest)	CFM	588/765/882	824/1,000/1,176	1,176/1,294/1,412
Sound Pressure - Cooling (lowest to highest)	dB(A)	37.2/40.4/43/45.2	37.2/40.4/43/45.2	37.2/40.4/43/45.2
Sound Pressure - Heating (lowest to highest)		35.8/38.7/41.7	37.9/43/46.5/48	50/51.9/53.9/54.9
Max Static Pressure	In W.C.	0.80	0.80	0.80
Field Drain Pipe Size O.D.	in (mm)	3/4 (19.1)	3/4 (19.1)	3/4 (19.1)

*Performance may vary based on the compatible outdoor units. See respective pages for performance data.

COMPATIBILITY:

Indoor Unit	Outdoor Unit Single Zone			Outdoor Unit Multi-Zone		
	38MARBQ24AA3	38MBRBQ36AA3	38MBRBQ48AA3	38MGRQ30D--3	38MGRQ36D--3	38MGRQ48E--3
40MBAAQ24XA3	•			•	•	•
40MBAAQ36XA3		•				
40MBAAQ48XA3			•			

Manufacturer reserves the right to discontinue, or change at any time, specification or designs without notice or incurring obligations.

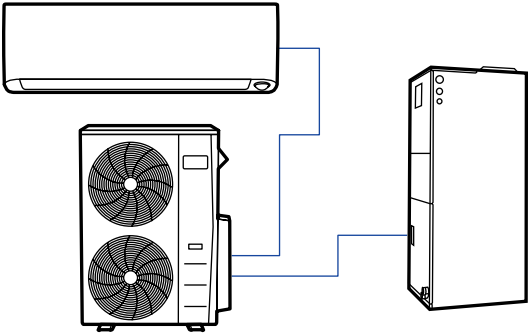

PERFORMANCE™ SERIES
 40MBFQ CONSOLE 40MBDQ DUCTED

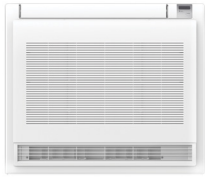

Floor Console Size 12



Console Size 18-24

Performance™ Floor Console Indoor Unit

FEATURES

- Modes: Cool, Heat, Dry, Fan, Auto
- Auto-restart function
- Louver control (fixed or swing)
- Three fan speeds
- Air discharge from top and bottom (size 12)
- *Follow Me* (senses temperature at handheld remote)
- Heating Setback (46° F Heating Mode)
- Quiet indoor operation, as low as 37 dB(A)
- Anti-corrosive fin coating

COMPATIBLE WITH:

- 38MARB Outdoor Unit Single Zone (p 26)
- 38MGR Outdoor Unit Multi-Zone (p 56)



Sizes: 12 / 18 /24

KEY FEATURES

2-Way Optional Air Outlet

Both up and down air-outlet or up air-outlet only. (Size 12 only.)

Outside Air Intake

Outside air is brought into the room via a connection pipe, which keeps the indoor air fresher and cleaner. (Sizes 18 to 24 only.)

CONTROLS

Wireless Remote Controller included with indoor unit
 Optional Wired Remote Controller KSACN0101AAA (Timer Function)

Optional Wired Remote Controller KSACN0601AAA (7-Day Programmable) Size 12

Optional Wired Remote Controller KSACN0701AAA (7-Day Programmable) Sizes 18 and 24



**Optional
 Wired Controller
 (Timer Function)
 KSACN0101AAA**



**Optional
 Wired Controller
 (7-Day Programmable)
 KSACN0601AAA or
 KSACN0701AAA**



**Wireless
 Remote
 Controller**

ACCESSORIES

Wi-Fi® Smartphone control kit KSAIF0401AAA (sizes 18-24)

24V Interface for compatibility with conventional thermostat KSAIC0301230

SPECIFICATIONS:

40MBFQ Console				
Heat Pump				
System				
Size		12	18	24
Indoor Model		40MBFQ12---3	40MBFQ18---3	40MBFQ24---3
Electrical				
Voltage, Phase, Cycle	V/Ph/Hz	208/230-1-60	208/230-1-60	208/230-1-60
Power Supply		Indoor Unit Powered From Outdoor Unit		
MCA	A	0.29	1.0	1.0
Controls				
Wireless Remote Controller (° F / ° C Convertible)		Standard		
Wired Remote Controller (° F / ° C Convertible)		Optional		
Operating Range				
Cooling Indoor DB Min - Max	° F (° C)	63~90 (17~32)	62~90 (17~32)	62~90 (17~32)
Heating Indoor DB Min - Max	° F (° C)	32~86 (0~30)	32~86 (0~30)	32~86 (0~30)
Piping				
Pipe Connection Size - Liquid	in (mm)	1/4 (6.35)	1/4 (6.35)	3/8 (9.52)
Pipe Connection Size - Suction	in (mm)	1/2 (12.7)	1/2 (12.7)	5/8 (16)
Indoor				
Unit Width	in (mm)	27.56 (700)	42.05 (1,068)	42.05 (1,068)
Unit Height	in (mm)	23.62 (600)	26.57 (675)	26.57 (675)
Unit Depth	in (mm)	8.27 (210)	9.25 (235)	9.25 (235)
Net Weight	lb (kg)	32.41 (14.7)	55.12 (25)	58.42 (26.5)
Number of Fan Speeds		3	3	3
Airflow (lowest to highest)	cfm	220/250/280	420/485/550	600/710/760
Sound Pressure (lowest to highest)	dB(A)	34/41/45	39/44/47	46/50/52
Air Throw Data	ft (m)	23 (7)	26 (8)	26 (8)
Field Drain Pipe Size O.D.	in (mm)	1 (25.4)	1 (25.4)	1 (25.4)

Performance may vary based on the compatible outdoor units. See respective pages for performance data.

COMPATIBILITY:

Indoor Unit	40MBFQ12---3	40MBFQ18---3	40MBFQ24---3
Outdoor Unit Single Zone	38MARBQ12AA3	38MARBQ18AA3	38MARBQ24AA3
Outdoor Unit Multi-Zone	38MGRQ18B--3		
	38MGRQ24C--3		
	38MGRQ30D--3		
	38MGRQ36D--3		
	38MGRQ48E--3		

Backward compatible with 38MAQ Single Zone and 38MGQ Multi-Zone Systems

COMFORT™ SERIES 38MHRC OUTDOOR UNIT

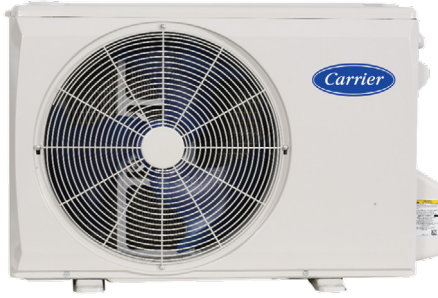

Comfort™ Heat Pump

FEATURES

- Cost competitive
- Factory installed basepan heater
- Factory installed crankcase heater
- Auto-restart function
- Condenser high-temperature protection
- Refrigerant leakage detection
- Quiet outdoor operation
- Anti-corrosive fin coating

COMPATIBLE WITH:

- 40MHHC High Wall Cooling only (p 45)
- 40MHHQ High Wall Heat Pump (p 42)

Comfort™
SERIES

Cooling Only - 38MHRCC

Heat Pump - 38MHRCQ With Basepan Heater

Sizes: 09 / 12 / 18 / 24 (208-230V); Size 12 (115V)

Up to 19.8 SEER

Up to 11.2 HSPF

KEY FEATURES

Easy Maintenance

Simple and fast installation and maintenance means less system downtime and costs.

Small Physical Size

With an optimized cabinet design and small footprint, the unit is unobtrusive and quiet.



High Wall

SPECIFICATIONS:

38MHRCQ Outdoor Unit						
Heat Pump						
System						
Size		12	9	12	18	24
Outdoor Model		38MHRCQ12AA1	38MHRCQ09AA3	38MHRCQ12AA3	38MHRCQ18AA3	38MHRCQ24AA3
Electrical						
Voltage-Phase-Cycle	V-Ph-Hz	115-1-60	208/230-1-60	208/230-1-60	208/230-1-60	208/230-1-60
MCA	A.	18.5	12	15	15	19
MOCP - Fuse Rating	A.	25	15	15	20	30
Operating Range						
Cooling Outdoor DB Min - Max	° F (° C)	0~122 (-17~50)	0~122 (-17~50)	0~122 (-17~50)	0~122 (-17~50)	0~122 (-17~50)
Cooling Outdoor DB Min - Max	° F (° C)	0~86 (-17~30)	0~86 (-17~30)	0~86 (-17~30)	0~86 (-17~30)	0~86 (-17~30)
Piping						
Total Piping Length	ft (m)	82 (25)	82 (25)	82 (25)	98 (30)	164 (50)
Piping Lift*	ft (m)	32 (10)	32 (10)	32 (10)	65 (20)	82 (25)
Pipe Connection Size - Liquid	in (mm)	1/4 (6.35)	1/4 (6.35)	1/4 (6.35)	1/4 (6.35)	3/8 (9.52)
Pipe Connection Size - Suction	in (mm)	1/2 (12.7)	3/8 (9.52)	1/2 (12.7)	1/2 (12.7)	5/8 (16)
Refrigerant						
Type		R410A	R410A	R410A	R410A	R410A
Charge	lbs (kg)	1.79 (0.81)	1.59 (0.72)	1.79 (0.81)	2.98 (1.35)	3.92 (1.78)
Compressor						
Type		Rotary Inverter	Rotary Inverter	Rotary Inverter	Rotary Inverter	Rotary Inverter
Outdoor						
Unit Width	in (mm)	30.12 (765)	30.12 (765)	30.12 (765)	31.69 (805)	35.04 (890)
Unit Height	in (mm)	21.85 (555)	21.85 (555)	21.85 (555)	21.81 (554)	26.50 (673)
Unit Depth	in (mm)	11.93 (303)	11.93 (303)	11.93 (303)	12.99 (330)	13.46 (342)
Net Weight	lbs (kg)	62.17 (28.2)	55.11 (25.0)	59.30 (26.9)	73.85 (33.5)	97.88 (44.4)
Airflow	CFM	1,235	1,294	1,235	1,235	1,765
Sound Pressure	dB(A)	53.5	55.0	55.5	55.0	59.5

*Condensing unit above or below indoor units.

COMPATIBILITY:

Indoor Unit		Outdoor Unit				
		38MHRCQ12AA1	38MHRCQ09AA3	38MHRCQ12AA3	38MHRCQ18AA3	38MHRCQ24AA3
40MHHQ High Wall	40MHHQ12---1	•				
	40MHHQ09---3		•			
	40MHHQ12---3			•		
	40MHHQ18---3				•	
	40MHHQ24---3					•

COMFORT™ SERIES

38MHRC OUTDOOR UNIT

PERFORMANCE:

40MHHQ High Wall						
Heat Pump						
Indoor Unit		40MHHQ12---1	40MHHQ09---3	40MHHQ12---3	40MHHQ18---3	40MHHQ24---3
ENERGY STAR®		NO	NO	NO	NO	NO
Cooling System Tons		1.0	0.8	1.0	1.5	2.0
Cooling Rated Capacity	Btu/h	12,000	9,000	12,000	18,000	24,000
Cooling Cap. Range Min - Max	Btu/h	4,500~12,100	2,650~9,500	3,300~13,000	3,760~19,900	6,760~24,300
SEER		19.8	18.5	19.8	19.0	19.0
EER		9.9	11.2	10.2	11.2	9.4
Heating Rated Capacity (47° F)	Btu/h	12,000	10,000	12,000	18,000	24,800
Heating Rated Capacity (17° F)	Btu/h	7,000	5,800	7,000	11,900	15,300
Heating Maximum Capacity (5° F)	Btu/h	7,000	6,500	8,000	10,000	14,000
Heating Cap. Range Min - Max	Btu/h	5,500~12,000	2,600~10,500	3,810~13,490	6,400~19,000	6,040~26,210
HSPF		10.8	10	10	11	10.2
COP (47° F)	W/W	3.00	3.30	3.11	3.20	3.13
COP (17° F)	W/W	2.35	2.25	2.50	2.72	2.62
COP (5° F)	W/W	1.60	1.75	1.75	2.00	1.75

PERFORMANCE:

40MHHC High Wall					
Cooling Only					
Indoor Unit		40MHHC12--A1	40MHHC12--A3	40MHHC18--3	40MHHC24--3
ENERGY STAR®		NO	NO	NO	NO
Cooling System Tons		1.0	1.0	1.4	2.0
Cooling Rated Capacity	Btu/h	11,500	11,500	17,000	24,000
Cooling Cap. Range Min - Max	Btu/h	3,200~12,800	3,200~12,900	4,500~18,000	6,760~24,300
SEER		20.5	20.5	19.0	17.1
EER		11.2	11.2	10.9	9.3

An economical choice that can
provide comfort when you need it.

SPECIFICATIONS:

38MHRC Outdoor Unit					
Cooling Only					
System					
Size		12	12	18	24
Outdoor Model		38MHRC12AA1	38MHRC12AA3	38MHRC18AA3	38MHRC24AA3
Electrical					
Voltage-Phase-Cycle	V-Ph-Hz	115-1-60	208/230-1-60	208/230-1-60	208/230-1-60
MCA	A.	19	9	19	19
MOCP - Fuse Rating	A.	30	15	30	30
Operating Range					
Cooling Outdoor DB Min - Max	° F (° C)	0~122 (-17~50)	0~122 (-17~50)	0~122 (-17~50)	0~122 (-17~50)
Piping					
Total Piping Length	ft (m)	82 (25)	82 (25)	98 (30)	164 (50)
Piping Lift*	ft (m)	33 (10)	33 (10)	66 (20)	66 (20)
Pipe Connection Size - Liquid	in (mm)	1/4 (6.35)	1/4 (6.35)	1/4 (6.35)	3/8 (9.52)
Pipe Connection Size - Suction	in (mm)	1/2 (12.7)	1/2 (12.7)	1/2 (12.7)	5/8 (16)
Refrigerant					
Type		R410A	R410A	R410A	R410A
Charge	lbs (kg)	1.43 (0.65)	1.43 (0.65)	1.98 (0.90)	3.92 (1.78)
Compressor					
Type		Rotary Inverter	Rotary Inverter	Rotary Inverter	Rotary Inverter
Outdoor					
Unit Width	in (mm)	28.35 (720)	28.35 (720)	30.12 (765)	35.04 (890)
Unit Height	in (mm)	19.49 (495)	19.49 (495)	21.85 (555)	26.50 (673)
Unit Depth	in (mm)	10.63 (270)	10.63 (270)	11.93 (303)	13.46 (342)
Net Weight	lbs (kg)	51.15 (23.2)	48.72 (22.1)	61.51 (27.9)	97.88 (44.4)
Airflow	CFM	1,059	1,059	1,235	1,765
Sound Pressure	dB(A)	52.0	52.5	55.5	59.5

*Condensing unit above or below indoor units.

COMPATIBILITY:

Indoor Unit		Outdoor Unit			
		38MHRC12AA1	38MHRC12AA3	38MHRC18AA3	38MHRC24AA3
40MHHC High Wall	40MHHC12--A1	•			
	40MHHC12--A3		•		
	40MHHC18--3			•	
	40MHHC24--3				•

COMFORT™ SERIES

40MHH HIGH WALL



Comfort™ High Wall Indoor Unit

FEATURES

- Available in 115V and 208/230V
- Modes: Cool, Heat, Dry, Fan, Auto
- Turbo Mode
- Up-down louver control (fixed or swing)
- **Filter removal from the top**
- **Improved serviceability**
- Four fan speeds
- Sleep Mode
- *Follow Me* (senses temperature at handheld remote)
- Heating Setback (46° F Heating Mode)
- Quiet indoor operation, as low as 27 dB(A)
- Anti-corrosive fin coating

COMPATIBLE WITH:

- 38MHRC Outdoor Unit Single Zone (p 40)
- 38MGR Outdoor Unit Multi-Zone (p 56)

Comfort™
SERIES

Cooling Only – 40MHHC

Heat Pump – 40MHHQ

Sizes: 09 / 12 / 18 / 24

KEY FEATURES

Improved Serviceability

Full access to the terminal connections and fan after lifting the front cover of the high wall for easy installation and service.

Convenient Filter Removal

The filter is conveniently located on the inlet, allowing direct removal from the top of the unit without opening the panel.

CONTROLS

Wireless Remote Controller included with indoor unit

Optional Wired Remote Controller (7-Day Programmable)



**Optional
Wired Controller
(7-Day Programmable)
KSACN0601AAA**



**Wireless
Remote
Controller**

ACCESSORIES

Wi-Fi® Smartphone control kit KSAIF0101AAA (sizes 09/12/24)

Wi-Fi® Smartphone control kit KSAIF0201AAA (size 18)

24V Interface for compatibility with conventional thermostat KSAIC0301230

SPECIFICATIONS:

40MHH High Wall					
Cooling Only					
System					
Size		12	12	18	24
Indoor Model		40MHHC12--A1	40MHHC12--A3	40MHHC18---3	40MHHC24---3
Electrical					
Voltage, Phase, Cycle	V/Ph/Hz	115-1-60	208/230-1-60	208/230-1-60	208/230-1-60
Power Supply		Indoor Unit Powered From Outdoor Unit			
MCA	A	0.2	0.1	0.27	0.4
Controls					
Wireless Remote Controller (° F / ° C Convertible)		Standard	Standard	Standard	Standard
Wired Remote Controller (° F / ° C Convertible)		Optional	Optional	Optional	Optional
Operating Range					
Cooling Indoor DB Min - Max	° F (° C)	62~90 (17~32)	62~90 (17~32)	62~90 (17~32)	62~90 (17~32)
Piping					
Pipe Connection Size - Liquid	in (mm)	1/4 (6.35)	1/4 (6.35)	1/4 (6.35)	3/8 (9.52)
Pipe Connection Size - Suction	in (mm)	1/2 (12.7)	1/2 (12.7)	1/2 (12.7)	5/8 (16)
Indoor					
Unit Width	in (mm)	32.00 (813)	32.00 (813)	38.36 (974)	43.83 (1113)
Unit Height	in (mm)	11.81 (300)	11.81 (300)	12.8 (325)	13.41 (341)
Unit Depth	in (mm)	7.75 (197)	7.75 (197)	8.87 (225)	9.22 (234)
Net Weight	lb (kg)	19.62 (8.9)	19.62 (8.9)	25.35 (11.5)	33.29 (15.1)
Number of Fan Speeds		4	4	4	4
Airflow (lowest to highest)	cfm	198/237/331/362	191/237/334/362	344/422/505/505	418/506/600/629
Sound Pressure (lowest to highest)	dB(A)	27/33/42/44	29/33/42/45	36/40/44/45	35/41/46/48
Air Throw Data	ft (m)	22 (6.7)	22 (6.7)	24 (7.3)	39.4 (12)
Moisture Removal	Pint/h (L/h)	3.17 (1.50)	3.09 (1.46)	4.38 (2.07)	6.38 (3.02)
Field Drain Pipe Size O.D.	in (mm)	5/8 (16)	5/8 (16)	5/8 (16)	5/8 (16)

Performance may vary based on the compatible outdoor units. See respective pages for performance data.

COMFORT™ SERIES

40MHH HIGH WALL

SPECIFICATIONS:

40MHH High Wall						
Heat Pump						
System						
Size		12	9	12	18	24
Indoor Model		40MHHQ12---1	40MHHQ09---3	40MHHQ12---3	40MHHQ18---3	40MHHQ24---3
Electrical						
Voltage, Phase, Cycle	V/Ph/Hz	115-1-60	208/230-1-60	208/230-1-60	208/230-1-60	208/230-1-60
Power Supply		Indoor Unit Powered From Outdoor Unit				
MCA	A	0.3	0.25	0.25	0.28	0.45
Controls						
Wireless Remote Controller (° F / ° C Convertible)		Standard	Standard	Standard	Standard	Standard
Wired Remote Controller (° F / ° C Convertible)		Optional	Optional	Optional	Optional	Optional
Operating Range						
Cooling Indoor DB Min - Max	° F (° C)	63~90 (17~32)	63~90 (17~32)	63~90 (17~32)	63~90 (17~32)	63~90 (17~32)
Heating Indoor DB Min - Max	° F (° C)	32~86 (0~30)	32~86 (0~30)	32~86 (0~30)	32~86 (0~30)	32~86 (0~30)
Piping						
Pipe Connection Size - Liquid	in (mm)	1/4 (6.35)	1/4 (6.35)	1/4 (6.35)	1/4 (6.35)	3/8 (9.52)
Pipe Connection Size - Suction	in (mm)	1/2 (12.7)	3/8 (9.52)	1/2 (12.7)	1/2 (12.7)	5/8 (16)
Indoor						
Unit Width	in (mm)	32.00 (813)	28.53 (725)	32.00 (813)	38.36 (974)	43.83 (1,113)
Unit Height	in (mm)	11.81 (300)	11.81 (300)	11.81 (300)	12.8 (325)	13.41 (341)
Unit Depth	in (mm)	7.75 (197)	7.75 (197)	7.75 (197)	8.87 (225)	9.22 (234)
Net Weight	lb (kg)	22.49 (10.2)	21.16 (9.6)	22.49 (10.2)	31.97 (14.5)	40.12 (18.2)
Number of Fan Speeds		4	4	4	4	4
Airflow (lowest to highest)	cfm	200/265/306/329	165/229/271/324	212/282/324/353	353/412/529/559	353/483/589/647
Sound Pressure (lowest to highest)	dB(A)	29/38/42/42	31/36/40/42	34/39/41/43	34/39/44/46	38/42/48/49
Air Throw Data	ft (m)	22 (6.7)	20.3 (6.2)	22.6 (6.9)	25 (7.6)	37.7 (11.5)
Moisture Removal	Pint/h (L/h)	3.49 (1.65)	2.05 (0.97)	3.38 (1.6)	4.63 (2.19)	5.73 (2.71)
Field Drain Pipe Size O.D.	in (mm)	0.625 (16)	0.625 (16)	0.625 (16)	0.625 (16)	0.625 (16)

Performance may vary based on the compatible outdoor units. See respective pages for performance data.

COMPATIBILITY:

Cooling Only				
Indoor Unit	40MHHC12--A1	40MHHC12--A3	40MHHC18---3	40MHHC24---3
Outdoor Unit Single Zone	38MHRCC12AA1	38MHRCC12AA3	38MHRCC18AA3	38MHRCC24AA3
Outdoor Unit Multi-Zone				

Backward compatible with 38MHRC Single Zone.

COMPATIBILITY:

Heat Pump					
Indoor Unit	40MHHQ12---1	40MHHQ09---3	40MHHQ12---3	40MHHQ18---3	40MHHQ24---3
Outdoor Unit Single Zone	38MHRQ12AA1	38MHRQ09AA3	38MHRQ12AA3	38MHRQ18AA3	38MHRQ24AA3
Outdoor Unit Multi-Zone		38MGRQ18B--3			
		38MGRQ24C--3			
		38MGRQ30D--3			
		38MGRQ36D--3			
	38MGRQ48E--3				

Backward compatible with 38MHRQ Single Zone.



MULTI-ZONE

INFINITY® SERIES 38VMH OUTDOOR UNIT



36, 48 and 60K

FEATURES

- Up to 18.6 SEER cooling efficiency
- Up to 10.0 HSPF heating efficiency
- Available in 3-, 4- and 5-ton capacity range
- 208/230-1-60Hz power supply
- Ability to connect up to nine multiple-style indoor units on a 5-ton system
- Heat pump system
- High-performance outdoor unit with Inverter-driven scroll compressor
- Cooling operating range 5° ~ 118° F
- Heating operating range -13° ~ 64° F
- Connected capacity up to 130%
- Quiet outdoor operation, as low as 58.7 dB(A)

COMPATIBLE WITH:

The 38VMH heat pump system can be matched with the following indoor units and controls:

40VMA, 40VMC, 40VMF, 40VMH, 40VML, 40VMM, 40VMR, 40VMU, 40VMV, 40VMW & 40VM9 (controller)

INFINITY SERIES

Infinity® Series VRF Heat Pump

CARRIER® VRF

Heat Pump System

36,000 to 60,000 Btu/h

3 to 5 tons

KEY FEATURES

The Carrier 38VMH VRF heat pump system is a combination of an outdoor unit with multiple-style indoor units connected by refrigerant piping and wiring. The outdoor units have stacked dual-condenser fan with side-blow arrangement



4-way Compact
Cassette 40VMC



4-way Cassette
40VMF



Low Static Duct
40VML



Medium Static Duct
40VMM



Floor Console
40VMR



Underceiling
40VMU



Vertical AHU
40VMV



High Wall
40VMW

SPECIFICATIONS:

38MVH Outdoor Unit						
System						
Outdoor Unit Model Name		38VMA036HDS3-1	38VMA048HDS3-1	38VMA060HDS3-1		
Nominal Tons	Ton	3	4	5		
Performance						
Cooling Capacity (*1) (with non-ducted indoor units/ducted)	Nominal	kBtu/h	36,000	48,000	60,000	
	Rated	kBtu/h	36,000	48,000	60,000	
Heating Capacity (*1) (with non-ducted indoor units/ducted)	Nominal	kBtu/h	40,000	52,500	66,000	
	Rated	kBtu/h	40,000	52,500	66,000	
Performance Non-Ducted						
With Non-Ducted Indoor Units	Power Supply (*2)		208/230V, 1-Phase, 60Hz			
	Cooling	Power Consumption	kW	3.1	4.6	6.1
		SEER (Seasonal Energy Efficiency Ratio)	Btu/W*hr	18.0	18.0	18.6
	Heating	Power Consumption	kW	3.1	4.3	5.8
		HSPF (Heating Seasonal Performance Factor)	Btu/W*hr	9.2	9.2	9.6
Performance Ducted						
With Ducted Indoor Units	Power Supply (*2)		208/230V, 1-Phase, 60Hz			
	Cooling	Power Consumption	kW	2.9	4.7	6.1
		SEER (Seasonal Energy Efficiency Ratio)	Btu/W*hr	17.8	17.8	18.6
	Heating	Power Consumption	kW	3.0	4.2	5.7
		HSPF (Heating Seasonal Performance Factor)	Btu/W*hr	9.6	9.6	10.0
Dimensions						
Height		in	52-1/4			
Width		in	35-1/2			
Depth		in	15-3/4			
Total Weight	Unit	lb	220			
Compressor						
Type/Quantity			Inverter-Driven Hermetic Rotary/1			
Motor Output		kW	13			
Fan Unit						
Motor Output		W	90+90			
Air Volume		cfm	4,100			
Refrigerant (*3) (charged refrigerant amount)		lb	8.6			
Electrical Specifications	Unit	MCA (*4)	A	36	38	40
		Recommended Fuse Size	A	40	40	45
Piping						
Refrigerant Piping	Connecting Port Diameter	Gas Side (main pipe) (brazing)	in	5/8	3/4	
		Liquid Side (main pipe) (brazing)	in	3/8		
Operation Temperature Range						
Cooling		°F DB	5~118			
Heating		°F WB	-13~64			
Indoor						
Maximum Number of Connected Indoor Units			5	7	9	
Maximum Capacity of Combined Indoor Units			50 to 130%			
Sound Pressure Level Cooling/Heating (*5)		dB(A)	58.7	60.1	60.7	

Specifications subject to change.

(*1) Rated conditions Cooling: Indoor air temperature 80 °F dry bulb / 67 °F wet bulb, outdoor air temperature 95 °F dry bulb.
 Heating: Indoor air temperature 70 °F dry bulb, outdoor air temperature 47 °F dry bulb / 43 °F wet bulb.

(*2) The source voltage must not fluctuate more than ±10%.

(*3) The amount does not consider extra piping length. Refrigerant must be added on site in accordance with the actual piping length.

(*4) Select wire size based on larger value of MCA.

MCA: Minimum Circuit Amps (Minimum Circuit Amps required for power supply design).

(*5) These values, measured in anechoic chamber, at a point 1m in front of the unit at a height of 1.4 m. During actual operation, these values are normally somewhat higher as a result of ambient conditions.

TOSHIBA CARRIER SERIES

MMYF HEAT RECOVERY OUTDOOR UNIT



Toshiba Carrier VRF Heat Recovery

FEATURES

- Available in 6-ton single module which can be twinned up to 12-ton capacity
- Ability to connect up to 25 indoor units
- 3-pipe heat recovery system
- High-performance outdoor units with all Inverter-driven twin rotary compressor
- DC inverter condenser fan motor
- 208/230-1-60Hz voltage
- Cooling ambient operating temperature is 14° ~ 122° F
- Heating ambient operating temperature is -13° ~ 60° F
- Connected capacity up to 150%

COMPATIBLE WITH:

The MMYF-SP heat recovery unit is matched with multiple VRF fan coils.

TOSHIBA
Carrier

TOSHIBA CARRIER VRF

Heat Recovery System

72,000 or 144,000 Btu/h

6 or 12 tons

KEY FEATURES

The Toshiba Carrier VRF system is a combination of an outdoor unit with multiple-style indoor units connected by refrigerant piping and wiring. The VRF heat recovery outdoor unit is a single module with twinning capability up to 12 tons to achieve greater capacity.

TOSHIBA CARRIER SERIES

MMYF HEAT RECOVERY OUTDOOR UNIT

Multi-Zone

SPECIFICATIONS:

MMYF Outdoor Unit				
System				
Outdoor Unit Set Model Name	MMY-	MAP0726FT2P-UL		AP1446FT2P-UL
Outdoor Unit Model Name	MMY-MAP			0726FT2P-UL
Nominal Tons	Ton	6	12	
Performance				
Cooling Capacity (*1) (with non-ducted indoor units/ducted)	Nominal	kBTu/h	72	144
	Rated	kBTu/h	69	138
Heating Capacity (*1) (with non-ducted indoor units/ducted)	Nominal	kBTu/h	81	162
	Rated	kBTu/h	77	154
Performance Non-Ducted				
With Non-ducted Indoor Units	Power Supply (*2)		208/230V, 1-Phase, 60Hz	
	Cooling	Power Consumption (*6)	kW	4.43
		IEER (Integrated Energy Efficiency Ratio)	Btu/W*hr	27.4
	Heating	Power Consumption (*6)	kW	5.98
SCHE (Simultaneous Cooling & Heating Efficiency)		Btu/W*hr	30.6	
Performance Ducted				
With Ducted Indoor Units	Power Supply (*2)		208/230V, 1-Phase, 60Hz	
	Cooling	Power Consumption (*6)	kW	4.88
		IEER (Integrated Energy Efficiency Ratio)	Btu/W*hr	20.6
	Heating	Power Consumption (*6)	kW	6.10
SCHE (Simultaneous Cooling & Heating Efficiency)		Btu/W*hr	27.8	
Dimensions				
Height		in	72.9	72.9
Width		in	39.0	39.0 x 2
Depth		in	30.7	30.7
Total Weight	Unit	lb	600	600 + 600
Compressor				
Type	Hermetic Twin Rotary Compressor			
Fan Unit				
Air Volume		cfm	5,900	5,900 x 2
Maximum External Static Pressure		in W.C.	0.24	0.24
Refrigerant (*3) (charged refrigerant amount)		lb	24.3	24.3 x 2
Electrical Specifications	Unit	MCA (*4)	A	47
		Recommended Fuse Size	A	50
Piping				
Refrigerant Piping	Connecting Port Diameter	Gas Side (main pipe) (brazing)	in	7/8
		Liquid Side (main pipe) (flare)	in	1/2
		Discharge (main pipe) (flare)	in	3/4
		Balance Pipe (flare)	in	3/8
Operation Temperature Range				
Cooling		° F DB	14~122	
Heating		° F WB	-13~60	
Indoor				
Maximum Number of Connected Indoor Units			12	25
Maximum Capacity of Combined Indoor Units			50 to 150%	
Sound Pressure Level Cooling/Heating (*5)		dB(A)	57/60	60/63

(*1) Rated conditions

 Cooling: Indoor 80° F Dry Bulb/67° F Wet Bulb, Outdoor 95° F Dry Bulb.
 Heating: Indoor 70° F Dry Bulb, Outdoor 47° F Dry Bulb/43° F Wet Bulb.

The standard pipe

144 type – 228 type	Equivalent piping length: 25 ft., Height difference: 0 ft.
---------------------	--

(*2) The source voltage must not fluctuate more than ±10%.

(*3) The amount does not consider extra piping length. Refrigerant must be added on site in accordance with the actual piping length.

(*4) Select wire size based on the larger value of MCA.

MCA: Minimum Circuit Amps (Minimum Circuit Amps required for power supply design).

(*5) In case the diversity exceeds 135%, the type of indoor unit is limited and the maximum number of indoor unit is reduced.

(*6) Only for outdoor unit.

TOSHIBA CARRIER SERIES MCY7 HEAT PUMP OUTDOOR UNIT



Toshiba Carrier VRF Heat Pump

FEATURES

- Available in 3-, 4- and 5-ton capacity range
- Ability to connect up to nine multiple-style indoor units on a 5-ton system
- Heat pump system
- High-performance outdoor unit with Inverter-driven twin rotary compressor
- 208/230-1-60Hz power supply
- Cooling operating range 23° ~ 122° F
- Heating operating range -13° ~ 60° F
- Connected capacity up to 135%
- Up to 21.5 SEER cooling efficiency
- Up to 11.5 HSPF heating efficiency
- Quiet outdoor operation

COMPATIBLE WITH:

The MCY7 heat pump is matched with multiple VRF fan coils.

TOSHIBA
Carrier

TOSHIBA CARRIER VRF

Heat Pump System

36,000 to 60,000 Btu/h

3 to 5 tons

KEY FEATURES

The Toshiba Carrier VRF System is a combination of an outdoor unit with multiple-style indoor units connected by refrigerant piping and wiring. The outdoor units have stacked dual-condenser fan with side-blow arrangement.

TOSHIBA CARRIER SERIES

MCY7 HEAT PUMP OUTDOOR UNIT

Multi-Zone

SPECIFICATIONS:

MCY7 Outdoor Unit							
System							
Outdoor Unit Model Name	MCY-		MAP0367HS-UL	MAP0487HS-UL	MAP0607HS-UL		
Nominal Tons		Ton	3	4	5		
Performance							
Cooling Capacity (*1) (with non-ducted indoor units/ducted)		Nominal	kBtu/h	36	48	60	
Heating Capacity (*1) (with non-ducted indoor units/ducted)		Nominal	kBtu/h	40	54	66	
Performance Non-Ducted							
With Non-Ducted Indoor Units	Power Supply (*2)		208/230V, 1-Phase, 60Hz				
	Cooling	Power Consumption	kW	2.29	3.71	5.26	
		EER (Energy Efficiency Ratio)	Btu/W*hr	15.7	12.95	11.4	
	Heating	Power Consumption	kW	2.79	3.95	5.16	
		COP (Coefficient of Performance)	Btu/W*hr	4.2	4.01	3.75	
	SEER (Seasonal Energy Efficiency Ratio)		22.7			21.0	20.5
	HSPF (Heating Seasonal Performance Ratio)		11.5			11.5	11.5
With Ducted Indoor Units	Power Supply (*2)		208/230V, 1-Phase, 60Hz				
	Cooling	Power Consumption	kW	2.76	4.87	5.76	
		EER (Energy Efficiency Ratio)	Btu/W*hr	13.05	9.85	10.42	
	Heating	Power Consumption	kW	3.45	5.27	5.34	
		COP (Coefficient of Performance)	Btu/W*hr	3.4	3.0	3.62	
	SEER (Seasonal Energy Efficiency Ratio)		17.7			16.6	17.6
	HSPF (Heating Seasonal Performance Ratio)		10.5			9.5	11.0
Dimensions							
Height		in	61	61	61		
Width		in	39.8	39.8	39.8		
Depth		in	14.6	14.6	14.6		
Total Weight	Unit	lb	311	311	311		
Compressor							
Type	Hermetic Twin Rotary Compressor						
Motor Output		kW	3.75	3.75	3.75		
Fan Unit							
Air Volume		cfm	4,520	4,690	4,850		
Refrigerant R410A (*3) (charged refrigerant amount)		lb	14.8	14.8	14.8		
Electrical Specifications	Unit	MCA (*4)	A	36.3	36.3	36.3	
		Recommended Fuse Size	A	40	40	40	
Piping							
Refrigerant Piping	Connecting Port Diameter	Gas Side (main pipe) (brazing)	in	5/8	5/8	3/4	
		Liquid Side (main pipe) (brazing)	in	3/8	3/8	3/8	
Operation Temperature Range							
Cooling		° F DB	23~122				
Heating		° F WB	-13~60				
Indoor							
Maximum Number of Connected Indoor Units			6	8	9		
Maximum Capacity of Combined Indoor Units			80 to 135%	50 to 135%			
Sound Pressure Level Cooling/Heating (*5)		dB(A)	52/56	54/57	55/58		

(*1) Rated conditions
Cooling: Indoor 80° F Dry Bulb/67° F Wet Bulb, Outdoor 95° F Dry Bulb.
Heating: Indoor 70° F Dry Bulb, Outdoor 47° F Dry Bulb/43° F Wet Bulb.

(*2) The source voltage must not fluctuate more than ±10%.

(*3) The amount does not consider extra piping length. Refrigerant must be added on site in accordance with the actual piping length.

(*4) Select wire size based on the larger value of MCA.

MCA: Minimum Circuit Amps (Minimum Circuit Amps required for power supply design).

PERFORMANCE™ SERIES

38MGR OUTDOOR UNIT



Performance™ Multi-Zone Heat Pump With Basepan Heater

FEATURES OUTDOOR:

- 100% heating capacity at 5° F (-15° C)
Sizes 24-36 (208/230V)
- Connect 2 ~ 5, multiple-style indoor units
- Basepan heater factory installed
- Quiet outdoor operation, as low as 62 dB(A)
- Anti-corrosive fin coating
- Total piping length 131 ~ 328 ft. (40 ~ 100 m.)
- Vertical lift/drop piping length 49 ~ 65 ft. (15 ~ 20 m.)
- Cooling operating range -13° ~ 122° F (-25° ~ 50° C)
- Heating operating range -22° ~ 86° F (-30° ~ 30° C)

COMPATIBLE WITH:

- 40MPHA High Wall (p 24)
- 40MAHB High Wall (p 30)
- 40MHHQ High Wall (p 46)
- 40MBCQ Cassette (p 32)
- 40MBDQ Ducted (p 34)
- 40MBFQ Floor Console (p 38)
- 40MBAA Air Handler (p 36)

Performance
SERIES

Heat Pump With Basepan Heater

Inverter Compressor

Up to 23.8 SEER

Up to 11.5 HSPF

Sizes: 18 / 24 / 30 / 36 / 48

Select Systems are ENERGY STAR® certified based on indoor combinations



KEY FEATURES

Space-saving Installation

Up to five indoor units can be connected to a single outdoor unit, reducing the number of outdoor units. All indoor units can be individually controlled and do not need to be installed at the same time.

Multiple-style Indoor Units

Flexibility on the options of indoor unit styles to fit any application or need.



High Wall

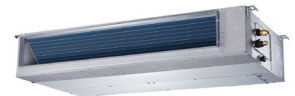

Cassette
Size 09 / 12 / 18

Cassette
Size 24

Ducted



Console
Size 12

Console
Size 18 & 24

Air Handler
Size 24

COMBINATIONS:

To access the Combination Charts, please see instructions on page 53.

Note: Multi-zone units cannot heat and cool simultaneously.

PERFORMANCE:

Non-Ducted										
Size	18		24		30		36		48	
Outdoor Model	38MGRQ18B--3		38MGRQ24C--3		38MGRQ30D--3		38MGRQ36D--3		38MGRQ48E--3	
Max Number of Zones	2		3		4		4		5	
Energy Star	YES		YES		YES		YES		YES	
Cooling System Tons	1.5		2.0		2.5		3.0		4.0	
Cooling Rated Capacity	Btu/h	18,000	24,000		30,000		36,000		48,000	
Cooling Cap. Range Min - Max	Btu/h	5,810~21,940	7,880~33,510		8,090~41,470		8,560~45,020		8,560~53,160	
SEER	22.5		23.0		23.8		21.5		22.4	
EER	12.5		12.5		12.5		13.5		12.5	
Heating Rated Capacity (47° F)	Btu/h	19,000	24,000		28,000		36,000		48,000	
Heating Maximum Capacity (5° F)	Btu/h	14,400	24,450		29,230		36,660		37,290	
Heating Cap. Range Min - Max	Btu/h	5,760~24,480	6,010~36,180		6,350~41,950		7,210~50,350		7,210~55,820	
HSPF	10.3		10.3		10.0		10.5		10.2	
COP (47° F)	W/W	3.6	3.9		3.8		3.8		3.6	
COP (5° F)	W/W	2.2	2.1		2.0		1.8		2.0	

Combination and Non-Ducted										
Size	18		24		30		36		48	
Outdoor Model	38MGRQ18B--3		38MGRQ24C--3		38MGRQ30D--3		38MGRQ36D--3		38MGRQ48E--3	
Max Number of Zones	2		3		4		4		5	
Energy Star	NO		NO		NO		NO		NO	
Cooling System Tons	1.5		2.0		2.5		3.0		4.0	
Cooling Rated Capacity	Btu/h	18,000	24,000		30,000		36,000		48,500	
Cooling Cap. Range Min - Max	Btu/h	5,795~20,708	7,765~31,955		8,060~39,990		8,510~42,635		8,510~52,580	
SEER	20.50		22.00		22.40		20.25		21.45	
EER	12.15		11.75		11.25		12.40		11.30	
Heating Rated Capacity (47° F)	Btu/h	18,700	24,000		29,000		36,400		49,000	
Heating Maximum Capacity (5° F)	Btu/h	14,565	24,150		28,615		36,065		37,045	
Heating Cap. Range Min - Max	Btu/h	5,650~24,365	5,980~36,190		6,275~42,305		7,045~47,800		7,045~54,935	
HSPF	10.15		10.15		10.00		10.75		10.85	
COP (47° F)	W/W	3.7	3.9		3.7		3.7		3.5	
COP (5° F)	W/W	2.1	2.0		2.0		1.8		1.9	

Ducted										
Size	18		24		30		36		48	
Outdoor Model	38MGRQ18B--3		38MGRQ24C--3		38MGRQ30D--3		38MGRQ36D--3		38MGRQ48E--3	
Max Number of Zones	2		3		4		4		5	
Energy Star	NO		NO		NO		NO		NO	
Cooling System Tons	1.5		2.0		2.5		3.0		4.1	
Cooling Rated Capacity	Btu/h	18,000	24,000		30,000		36,000		49,000	
Cooling Cap. Range Min - Max	Btu/h	5,780~19,476	7,650~30,400		8,030~38,510		8,460~40,250		8,460~52,000	
SEER	18.5		21.0		21.0		19.0		20.5	
EER	11.8		11.0		10.0		11.3		10.1	
Heating Rated Capacity (47° F)	Btu/h	18,500	24,000		30,000		37,000		50,000	
Heating Maximum Capacity (5° F)	Btu/h	14,730	23,850		28,000		35,470		36,800	
Heating Cap. Range Min - Max	Btu/h	5,539~24,249	5,950~36,200		6,200~42,660		6,880~45,250		6,880~54,050	
HSPF	10.0		10.0		10.0		11.0		11.5	
COP (47° F)	W/W	3.8	3.8		3.6		3.6		3.4	
COP (5° F)	W/W	2.10	1.96		1.98		1.75		1.82	

PERFORMANCE™ SERIES

38MGR OUTDOOR UNIT

SPECIFICATIONS:

38MGR Outdoor Unit						
Heat Pump						
System						
Size		18	24	30	36	48
Outdoor Model		38MGRQ18B--3	38MGRQ24C--3	38MGRQ30D--3	38MGRQ36D--3	38MGRQ48E--3
Max Number of Zones		2	3	4	4	5
Operating Range						
Cooling Outdoor DB Min - Max	° F (° C)	-13~-122 (-25~-50)	-13~-122 (-25~-50)	-13~-122 (-25~-50)	-13~-122 (-25~-50)	-13~-122 (-25~-50)
Heating Outdoor DB Min - Max	° F (° C)	-22~-86 (-30~-30)	-22~-86 (-30~-30)	-22~-86 (-30~-30)	-22~-86 (-30~-30)	-22~-86 (-30~-30)
Piping						
Total Piping Length	ft (m)	131(40)	197(60)	263(80)	328(100)	328(100)
Piping to furthest FCU	ft (m)	82 (25)	98 (30)	115(35)	115(35)	115 (35)
Drop (OD above ID)	ft (m)	49 (15)	49 (15)	49 (15)	65 (20)	65 (20)
Lift (OD below ID)	ft (m)	49 (15)	49 (15)	49 (15)	65 (20)	65 (20)
Pipe Connection Size - Liquid	in (mm)	1/4*2 (6.35*2)	1/4*3 (6.35*3)	1/4*4 (6.35*4)	1/4*4 (6.35*4)	1/4*5 (6.35*5)
Pipe Connection Size - Suction	in (mm)	3/8*2 (9.52*2)	3/8*3 (9.52*3)	1/2 *1+ 3/8*3 (12.7*1+9.52*3)	1/2 *2+ 3/8*2 (12.7*2+9.52*2)	1/2 *2+ 3/8*3 (12.7*2+9.52*3)
Refrigerant						
Type		R410A	R410A	R410A	R410A	R410A
Charge	lbs (kg)	4.41 (2.0)	6.17(2.8)	6.61 (3.0)	10.13 (4.6)	10.13 (4.6)
Electrical						
Voltage-Phase-Cycle	V-Ph-Hz	208/230-1-60	208/230-1-60	208/230-1-60	208/230-1-60	208/230-1-60
Power Supply		Indoor Unit Powered From Outdoor Unit				
MCA	A.	18	25	30	35	35
MOCP - Fuse Rating	A.	25	35	45	50	50
Compressor						
Type		Rotary Inverter	Rotary Inverter	Rotary Inverter	Rotary Inverter	Rotary Inverter
Outdoor						
Unit Width	in (mm)	37.31 (948)	41.22 (1047)	41.22 (1047)	41.15 (1045)	41.15 (1045)
Unit Height	in (mm)	27.64 (702)	31.88 (810)	31.88 (810)	52.48 (1333)	52.48 (1333)
Unit Depth	in (mm)	14.82 (376)	17.91 (455)	17.91 (455)	17.63 (448)	17.63 (448)
Net Weight	lbs (kg)	105.8 (48)	149.9 (68)	156.5 (71)	221.6 (100.5)	223.8 (101.5)
Airflow	CFM	1,390	2,130	2,130	4,500	4,500
Sound Pressure	dB(A)	62	63	62	64	64

COMPATIBILITY:

Indoor Unit		Outdoor Unit				
		38MGRQ18B--3	38MGRQ24C--3	38MGRQ30D--3	38MGRQ36D--3	38MGRQ48E--3
40MPHA High Wall	40MPHAQ09XA3	•	•	•	•	•
	40MPHAQ12XA3	•	•	•	•	•
40MAHB High Wall	40MAHBQ06A3	•	•	•	•	•
	40MAHBQ09B--3	•	•	•	•	•
	40MAHBQ12B--3	•	•	•	•	•
	40MAHBQ18B--3		•	•	•	•
	40MAHBQ24B--3			•	•	•
40MHHQ High Wall	40MHHQ09---3	•	•	•	•	•
	40MHHQ12---3	•	•	•	•	•
	40MHHQ18---3		•	•	•	•
	40MHHQ24---3			•	•	•
40MBCQ Cassette	40MBCQ09---3	•	•	•	•	•
	40MBCQ12---3	•	•	•	•	•
	40MBCQ18---3		•	•	•	•
	40MBCQ24---3			•	•	•
40MBCQ Ducted	40MBDQ09---3	•	•	•	•	•
	40MBDQ12---3	•	•	•	•	•
	40MBDQ18---3		•	•	•	•
	40MBDQ24---3			•	•	•
40MBFQ Console	40MBFQ12---3	•	•	•	•	•
	40MBFQ18---3		•	•	•	•
	40MBFQ24---3			•	•	•
40MBAA Air Handler	40MBAAQ24XA3			•	•	•

RATED COMBINATIONS:

Outdoor Models	Two Zones		Three Zones				Four Zones				Five Zones							
38MGRQ18B--3	6+6	9+9																
	6+9	9+12																
	6+12	12+12																
38MGRQ24C--3	6+6		6+6+6	6+9+9	6+12+18	12+12+12												
	6+9	9+9	12+12	6+6+9	6+9+12	9+9+9												
	6+12	9+12	12+18	6+6+12	6+9+18	9+9+12												
	6+18	9+18	18+18	6+6+18	6+12+12	9+9+18												
38MGRQ30D--3	6+9	9+9	12+12	6+6+12	6+9+24	9+9+9	9+18+18	6+6+6+6	6+6+9+12	6+9+9+9	6+12+12+12	9+9+12+18						
	6+12	9+12	12+18	6+6+18	6+12+12	9+9+12	12+12+12	6+6+6+9	6+6+9+18	6+9+9+12	6+12+12+18	9+12+12+12						
	6+18	9+18	12+24	6+6+24	6+12+18	9+9+18	12+18+18	6+6+6+12	6+6+9+24	6+9+9+18	6+12+12+18	9+9+12+12+12						
	6+24	9+24	18+18	6+9+9	6+12+24	9+9+24	12+18+18	6+6+6+18	6+6+12+12	6+9+9+24	9+9+9+12							
				6+9+12	6+18+18	9+12+12	12+12+24	6+6+6+24	6+6+12+18	6+9+12+12	9+9+9+18							
				6+9+18	6+18+24	9+12+18		6+6+9+9	6+6+12+24	6+9+12+18	9+9+12+12							
38MGRQ36D--3	6+18	9+18	12+12	6+6+24	9+9+9	9+18+24	18+18+18	6+6+6+18	6+6+18+24	6+9+18+18	9+9+9+12	9+12+12+12						
	6+24	9+24	12+18	6+6+36	9+9+12	9+24+24	18+18+24	6+6+6+24	6+6+24+24	6+9+18+24	9+9+9+18	9+12+12+18						
			12+24	6+9+24	9+9+18	12+12+12		6+6+9+18	6+9+9+12	6+12+12+12	9+9+9+24	9+12+12+24						
			18+18	6+12+18	9+9+24	12+12+18		6+6+9+24	6+9+9+18	6+12+12+18	9+9+12+12	9+12+18+18						
			18+24	6+12+24	9+12+12	12+12+24		6+6+12+12	6+9+9+24	6+12+12+24	9+9+12+18	9+18+18+18						
			24+24	6+18+18	9+12+18	12+18+18		6+6+12+18	6+9+12+12	6+12+18+18	9+9+12+24	12+12+12+12						
				6+18+24	9+12+24	12+18+24		6+6+12+24	6+9+12+18	6+12+18+24	9+9+18+18	12+12+18+18						
				6+24+24	9+18+18	12+24+24		6+6+18+18	6+9+12+24	9+9+9+9	9+9+18+24	12+12+12+24						
38MGRQ48E--3	6+18		9+18	6+6+24	9+9+9	9+18+24	18+18+18	6+6+6+18	6+6+18+24	6+9+18+18	9+9+9+12	9+12+12+12	6+6+6+6+9	6+6+6+12+18	6+6+9+9+12	6+9+12+12+24	9+9+9+18+18	
	6+24		9+24	6+9+24	9+9+12	9+24+24	18+18+24	6+6+6+24	6+6+24+24	6+9+18+24	9+9+9+18	9+12+12+18	6+6+6+6+12	6+6+6+12+24	6+6+9+9+18	6+12+12+12+12	9+9+12+12+12	
			12+12	6+12+18	9+9+18	12+12+12		6+6+9+18	6+9+9+12	6+12+12+12	9+9+9+24	9+12+12+24	6+6+6+6+18	6+6+6+18+18	6+6+9+9+24	6+12+12+12+18	9+9+12+12+18	
			12+18	6+12+24	9+9+24	12+12+18		6+6+9+24	6+9+9+18	6+12+12+18	9+9+12+12	9+12+18+18	6+6+6+6+18	6+6+6+18+24	6+6+9+9+12	6+9+9+12+12	9+9+9+12+12	9+12+12+12+12
			12+24	6+18+18	9+12+12	12+12+24		6+6+12+12	6+9+9+24	6+12+12+24	9+9+12+18	9+18+18+18	6+6+6+6+18	6+6+6+18+24	6+6+9+9+12	6+9+9+12+18	9+9+9+12+18	9+12+12+12+18
			18+18	6+18+24	9+12+18	12+18+18		6+6+12+18	6+9+12+12	6+12+18+18	9+9+12+24	9+12+12+12	6+6+6+6+18	6+6+6+18+24	6+6+9+9+12	6+9+9+12+24	9+9+9+12+18	12+12+12+12+12
			18+24	6+24+24	9+12+24	12+18+24		6+6+12+24	6+9+12+18	6+12+18+24	9+9+12+18	9+12+12+18	6+6+6+6+18	6+6+6+18+24	6+6+9+9+12	6+9+9+12+24	9+9+9+12+18	
			24+24	9+9+9	9+18+18	12+24+24		6+6+18+18	6+9+12+24	9+9+9+9	9+9+18+24	12+12+12+24	6+6+6+6+18	6+6+6+18+24	6+6+9+9+12	6+9+9+12+12	9+9+9+12+18	
												12+12+18+18	6+6+6+12+12	6+6+9+12+12	6+9+12+18	9+9+9+12+18		



*LIGHT
COMMERCIAL*

PERFORMANCE™ SERIES
38MBR OUTDOOR UNIT



58K

Performance™ Commercial Heat Pump

FEATURES OUTDOOR

- Inverter Compressor
- Built-in basepan heater
- Condenser high-temperature protection
- Refrigerant leakage detection
- Quiet outdoor operation, as low as 64 dB(A)
- Anti-corrosive fin coating
- Piping length 213 ft. (65 m.)
- Cooling operating range -13° ~ 122° F (-25° ~ 50° C)
- Heating operating range -22°~86°F (-30° ~ 30° C)

COMPATIBLE WITH:

- 40MBDQ Ducted (p 70)
- 40MBFQ Console (p 72)



Heat Pump With Basepan Heater

Inverter Compressor
 Up to 18.0 SEER
 Up to 10.5 HSPF
 Sizes: 58

KEY FEATURES

Longer Piping Lengths

Piping flexibility up to a total piping length of 213 ft. (65m.).

Low Ambient Cooling

With built-in low ambient kit or special designed PCB, outdoor fan speeds can be changed automatically based on the temperature. The unit can run cooling operation even in low ambient temperatures.



Console

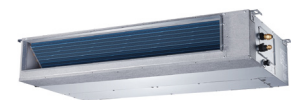

Ducted

SPECIFICATIONS:

38MBR Outdoor Unit		
Heat Pump		
System		
Size		58
Outdoor Model		38MBRBQ58A--3
Electrical		
Voltage, Phase, Cycle	V/Ph/Hz	208/230-1-60
MCA	A	35
MOCP - Fuse Rating	A	50
Operating Range		
Cooling Outdoor DB Min - Max	° F (° C)	-13~122 (-25~50)
Heating Outdoor DB Min - Max	° F (° C)	-22~86 (-30~30)
Piping		
Total Piping Length	ft (m)	213 (65)
Piping Lift*	ft (m)	98 (30)
Pipe Connection Size - Liquid	in (mm)	3/8 (9.52)
Pipe Connection Size - Suction	in (mm)	3/4 (19)
Refrigerant		
Type		R410A
Charge	lb (kg)	10.19 (4.62)
Compressor		
Type		Rotary Inverter
Outdoor		
Unit Width	in (mm)	37.48 (952)
Unit Height	in (mm)	52.48 (1,333)
Unit Depth	in (mm)	16.34 (415)
Net Weight	lb (kg)	225.09 (102.1)
Airflow	cfm	4,415
Sound Pressure	dB(A)	64.0

*Condensing unit above or below indoor unit.

COMPATIBILITY:

Indoor Unit		Outdoor Unit
		38MBRBQ58A--3
Ducted	40MBDQ58---3	•
Console	40MBFQ58---3	•

PERFORMANCE:

40MBDQ Ducted		
Indoor Model		40MBDQ58---3
ENERGY STAR®		NO
Cooling System Tons		4.8
Cooling Rated Capacity	Btu/h	57,000
Cooling Cap. Range Min - Max	Btu/h	18,000~58,000
SEER		18.0
EER		10.0
Heating Rated Capacity (47° F)	Btu/h	62,000
Heating Rated Capacity (17° F)	Btu/h	37,600
Heating Capacity (5° F)	Btu/h	35,000
Heating Cap. Range Min - Max	Btu/h	12,000~63,000
HSPF		9.0
COP (47° F)	W/W	3.6
COP (17° F)	W/W	2.62
COP (5° F)	W/W	1.91

40MBFQ Console		
Indoor Model		40MBFQ58---3
ENERGY STAR®		NO
Cooling System Tons		4.5
Cooling Rated Capacity	Btu/h	54,000
Cooling Cap. Range Min - Max	Btu/h	18,000~58,000
SEER		18
EER		9.8
Heating Rated Capacity (47° F)	Btu/h	60,000
Heating Rated Capacity (17° F)	Btu/h	39,000
Heating Capacity (5° F)	Btu/h	35,000
Heating Cap. Range Min - Max	Btu/h	12,000~63,000
HSPF		10.5
COP (47° F)	W/W	3.6
COP (17° F)	W/W	2.62
COP (5° F)	W/W	1.91

PERFORMANCE™ SERIES
38MBRB OUTDOOR UNIT



36K



48K

Performance™ Commercial Heat Pump

FEATURES OUTDOOR

- Built-in basepan heater
- Condenser high-temperature protection
- Refrigerant leakage detection
- Quiet outdoor operation
- Anti-corrosive fin coating
- Piping length 213 ft. (65 m)
- Cooling operating range -13° ~ 122° F (-25° ~ 50° C)
- Heating operating range -22° ~ 86° F (-30° ~ 30° C)

COMPATIBLE WITH:

- 40MBAA Air Handler (p 74)
- 40MBCQ Cassette (p 68)
- 40MBDQ Ducted (p 70)
- 40MBFQ Floor Console (p 72)



Heat Pump with Basepan Heater

Inverter Compressor
Up to 18.0 SEER
Up to 11.5 HSPF
Sizes: 36 / 48

KEY FEATURES

Flexible Installation

Piping flexibility up to a total piping length of 213 ft. (65 m).

Low Ambient Cooling



Air Handler
Size 36 / 48



Cassette



Ducted



Floor Console

SPECIFICATIONS:

38MBRB Outdoor Unit			
Heat Pump			
System			
Size		36	48
Outdoor Model		38MBRBQ36AA3	38MBRBQ48AA3
Electrical			
Voltage-Phase-Cycle	V-Ph-Hz	208/230-1-60	208/230-1-60
MCA	A.	30	36.5
MOCP - Fuse Rating	A.	45	50
Operating Range			
Cooling Outdoor DB Min - Max	° F (° C)	-13~122 (-25~50)	-13~122 (-25~50)
Heating Outdoor DB Min - Max	° F (° C)	-22~86 (-30~30)	-22~86 (-30~30)
Piping			
Total Piping Length	ft (m)	213 (65)	213 (65)
Piping Lift*	ft (m)	98 (30)	98 (30)
Pipe Connection Size - Liquid	in (mm)	3/8 (9.52)	3/8 (9.52)
Pipe Connection Size - Suction	in (mm)	5/8 (16)	5/8 (16)
Refrigerant			
Type		R410A	R410A
Charge	lbs (kg)	7.05 (3.2)	9.92 (4.5)
Compressor			
Type		Rotary Inverter	Rotary Inverter
Outdoor			
Unit Width	in (mm)	41.1 (1,045)	40.5 (1,030)
Unit Height	in (mm)	31.9 (810)	52.4 (1,333)
Unit Depth	in (mm)	17.9 (455)	17.6 (448)
Net Weight	lbs (kg)	155.42 (70.5)	219.14 (99.4)
Airflow	CFM	2,118	4,500
Sound Pressure	dB(A)	61.7	62.9

*Condensing unit above or below indoor unit.

COMPATIBILITY:

Indoor Unit		Outdoor Unit	
		38MBRBQ36AA3	38MBRBQ48AA3
40MBDQ Ducted	40MBDQ36---3	•	
	40MBDQ48---3		•
40MBAA Air Handler	40MBAAQ36XA3	•	
	40MBAAQ48XA3		•
40MBFQ Floor Console	40MBFQ36---3	•	
	40MBFQ48---3		•
40MBCQ Cassette	40MBCQ36---3	•	
	40MBCQ48---3		•

PERFORMANCE™ SERIES

38MBRB OUTDOOR UNIT

PERFORMANCE:

40MBCQ Cassette			
Indoor Model		40MBCQ36---3	40MBCQ48---3
ENERGY STAR®		NO	NO
Cooling System Tons		3.0	4.0
Cooling Rated Capacity	Btu/h	36,000	48,000
Cooling Cap. Range Min - Max	Btu/h	7,500~52,200	14,300~70,000
SEER		17.60	17.00
EER		9.00	9.50
Heating Rated Capacity (47° F)	Btu/h	38,000	50,000
Heating Rated Capacity (17° F)	Btu/h	22,000	29,000
Heating Capacity (5° F)	Btu/h	32,200	37,400
Heating Cap. Range Min - Max	Btu/h	12,600~55,800	15,200~59,600
HSPF		10.6	11.0
COP (47° F)	W/W	3.01	3.10
COP (17° F)	W/W	2.49	2.50
COP (5° F)	W/W	2.41	2.45

PERFORMANCE:

40MDQ Ducted			
Indoor Model		40MBDQ36---3	40MBDQ48---3
ENERGY STAR®		NO	NO
Cooling System Tons		3.0	4.0
Cooling Rated Capacity	Btu/h	36,000	48,000
Cooling Cap. Range Min - Max	Btu/h	7,500~52,100	15,700~76,700
SEER		16.7	17.4
EER		9	9.2
Heating Rated Capacity (47° F)	Btu/h	40,000	50,000
Heating Rated Capacity (17° F)	Btu/h	27,000	29,000
Heating Capacity (5° F)	Btu/h	29,100	39,900
Heating Cap. Range Min - Max	Btu/h	11,400~50,500	20,200~63,600
HSPF		11.5	10.3
COP (47° F)	W/W	3.37	3
COP (17° F)	W/W	2.6	2.5
COP (5° F)	W/W	2.5	2.19

PERFORMANCE™ SERIES
38MBR OUTDOOR UNIT

PERFORMANCE:

40MBFQ Floor Console			
Indoor Model		40MBFQ36---3	40MBFQ48---3
ENERGY STAR®		NO	NO
Cooling System Tons		3.0	4.0
Cooling Rated Capacity	Btu/h	36,000	48,000
Cooling Cap. Range Min - Max	Btu/h	7,500~52,100	15,000~73,600
SEER		17	18
EER		8	9.3
Heating Rated Capacity (47° F)	Btu/h	38,000	50,000
Heating Rated Capacity (17° F)	Btu/h	22,000	29,000
Heating Capacity (5° F)	Btu/h	29,300	42,700
Heating Cap. Range Min - Max	Btu/h	11,400~50,000	17,400~68,000
HSPF		10.0	11.0
COP (47° F)	W/W	2.8	2.5
COP (17° F)	W/W	2.3	2.3
COP (5° F)	W/W	2.05	2.48

PERFORMANCE:

40MBAA Air Handler			
Indoor Model		40MBAAQ36XA3	40MBAAQ48XA3
Outdoor Model		38MBRBQ36AA3	38MBRBQ48AA3
ENERGY STAR®		NO	NO
Cooling System Tons		3.0	4.0
Cooling Rated Capacity	Btu/h	36,000	48,000
Cooling Cap. Range Min - Max	Btu/h	7,500~52,200	14,300~70,000
SEER		16.5	16
EER		8.5	8.2
Heating Rated Capacity (47° F)	Btu/h	39,000	55,000
Heating Rated Capacity (17° F)	Btu/h	25,000	36,000
Heating Capacity (5° F)	Btu/h	25,800	31,500
Heating Cap. Range Min - Max	Btu/h	11,800~45,400	15,200~62,700
HSPF		10.4	9.5
COP (47° F)	W/W	3.20	2.60
COP (17° F)	W/W	2.45	2.30
COP (5° F)	W/W	2.3	2.08

PERFORMANCE™ SERIES
40MBCQ CASSETTE



Performance™ Cassette Indoor Unit

FEATURES OUTDOOR

- Modes: Cool, Heat, Dry, Fan, Auto
- Auto-restart function
- Louver control (fixed or swing)
- Three fan speeds
- Outside air intake
- Built-in condensate lift pump
- *Follow Me* (senses temperature at handheld remote)
- Heating Setback (46° F Heating Mode)
- Quiet indoor operation, as low as 49 dB(A)
- Anti-corrosive fin coating
- Grille/ceiling panel 3" x 3" P/N 40MBCQ02XXX3

COMPATIBLE WITH:

- 38MBRB Outdoor Unit Single Zone

(p 64)



Sizes: 36 / 48

KEY FEATURES

Built-in Condensate Lift Pump

The cassette is supplied with a condensate lift pump that is capable of lifting the water 29.5in. (750mm.) above the top of the unit.

360° Airflow Panel

With the 360° Airflow panel, air is distributed to every corner of the room.

CONTROLS

Wireless Remote Controller included with indoor unit

Optional Wired Remote Controller KSACN0101AAA (Timer Function)

Optional Wired Remote Controller KSACN0701AAA (7-Day Programmable)



**Optional
Wired Controller
(Timer Function)
KSACN0101AAA**



**Optional
Wired Controller
(7-Day Programmable)
KSACN0701AAA**



**Wireless
Remote
Controller**

ACCESSORIES

Wi-Fi® Smartphone control kit KSAIF0401AAA

24V Interface for third-party thermostat compatibility KSAIC0301230

Grille is required; sold separately.

SPECIFICATIONS:

40MBCQ Cassette			
Heat Pump			
System			
Size		36	48
Indoor Model		40MBCQ36---3	40MBCQ48---3
Electrical			
Voltage, Phase, Cycle	V/Ph/Hz	208/230-1-60	208/230-1-60
Power Supply		Indoor Unit Powered From Outdoor Unit	
MCA	A	0.8	1.6
Controls			
Wireless Remote Controller (° F / ° C Convertible)		Standard	Standard
Wired Remote Controller (° F / ° C Convertible)		Optional	Optional
Operating Range			
Cooling Indoor DB Min - Max	° F (° C)	63~90 (17~32)	63~90 (17~32)
Heating Indoor DB Min - Max	° F (° C)	32~86 (0~30)	32~86 (0~30)
Piping			
Pipe Connection Size - Liquid	in (mm)	3/8 (9.52)	3/8 (9.52)
Pipe Connection Size - Suction	in (mm)	5/8 (16)	5/8 (16)
Indoor			
Body Unit Width	in (mm)	33.07 (840)	33.07 (840)
Body Unit Height	in (mm)	9.65 (245)	11.3 (287)
Body Unit Depth	in (mm)	33.07 (840)	33.07 (840)
Body Net Weight	lb (kg)	58.2 (26.4)	63.27 (28.7)
Panel Unit Width	in (mm)	37.4 (950)	37.4 (950)
Panel Unit Height	in (mm)	2.17 (55)	2.17 (55)
Panel Unit Depth	in (mm)	37.4 (950)	37.4 (950)
Panel Net Weight	lb (kg)	11.02 (5)	11.02 (5)
Number of Fan Speeds		3	3
Airflow (lowest to highest)	cfm	809/958/1,095	853/1,030/1,177
Sound Pressure (lowest to highest)	dB(A)	49/52/55	49/52/55
Air Throw Data	ft (m)	30 (9)	30 (9)
Moisture Removal	Pint/h (L/h)	8.53 (4.04)	13.5 (6.39)
Field Drain Pipe Size O.D.	in (mm)	1 (25.4)	1 (25.4)

Performance may vary based on the compatible outdoor units. See respective pages for performance data.

COMPATIBILITY:

Indoor Unit	40MBCQ36---3	40MBCQ48---3
Outdoor Unit Single Zone	38MBRQ36A--3	38MBRQ48A--3

PERFORMANCE™ SERIES
40MBDQ DUCTED:

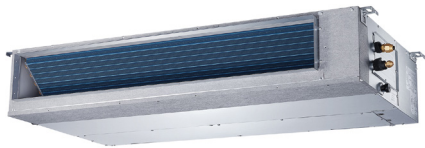

36K & 48K



58K

Performance™ Ducted Indoor Unit

FEATURES OUTDOOR

- Modes: Cool, Heat, Dry, Fan, Auto
- Vertical (sizes 36 & 48) or horizontal installation
- Up to 0.8 in W.C.
- Rear or bottom return
- Outside air intake
- Built-in condensate lift pump
- *Follow Me* (senses temperature at handheld remote)
- Heating Setback (46° F Heating Mode)
- Quiet indoor operation, as low as 38.5 dB(A)
- Anti-corrosive fin coating

COMPATIBLE WITH:

- 38MBR Outdoor Unit Single Zone (p 62)
- 38MBRB Outdoor Unit (p 64)

Performance
SERIES

Sizes: 36 / 48 / 58

KEY FEATURES

Vertical or Horizontal Installation

Designed for maximum installation flexibility. The secondary drain built-in allows the unit to be mounted vertically allowing either a floor or ceiling-concealed installation depending on existing conditions. (Sizes 36 and 48 only.)

Built-in Condensate Lift Pump

Supplied with a condensate lift pump that is capable of lifting the water 29.5in. (750mm.) above the top of the unit.

CONTROLS

Wireless Remote Controller included with indoor unit

Wired Remote Controller (7-Day Programmable) included with indoor unit



**Standard
Wired Controller
(7-Day Programmable)
KSACN0701AAA**



**Wireless
Remote
Controller**

ACCESSORIES

Wi-Fi® Smartphone control kit KSAIF0401AAA

24V Interface for third-party thermostat compatibility KSAIC0301230

SPECIFICATIONS:

40MBDQ Ducted				
Heat Pump				
System				
Size		36	48	58
Indoor Model		40MBDQ36---3	40MBDQ48---3	40MBDQ58---3
Electrical				
Voltage, Phase, Cycle	V/Ph/Hz	208/230-1-60	208/230-1-60	208/230-1-60
Power Supply		Indoor Unit Powered From Outdoor Unit		
MCA	A	2.45	3.2	3.65
Controls				
Wireless Remote Controller (° F / ° C Convertible)		Standard	Standard	Standard
Wired Remote Controller (° F / ° C Convertible)		Standard	Standard	Standard
Operating Range				
Cooling Indoor DB Min - Max	° F (° C)	63~90 (17~32)	63~90 (17~32)	63~90 (17~32)
Heating Indoor DB Min - Max	° F (° C)	32~86 (0~30)	32~86 (0~30)	32~86 (0~30)
Piping				
Pipe Connection Size - Liquid	in (mm)	3/8 (9.52)	3/8 (9.52)	3/8 (9.52)
Pipe Connection Size - Suction	in (mm)	5/8 (16)	5/8 (16)	3/4 (19)
Indoor				
Unit Width	in (mm)	53.54 (1,360)	47.24 (1,200)	55.12 (1,400)
Unit Height	in (mm)	9.8 (249)	11.81 (300)	17.32 (440)
Unit Depth	in (mm)	30.47 (774)	34.41 (874)	33.78 (858)
Net Weight	lb (kg)	106.48 (48.3)	119.71 (54.3)	163 (74)
Number of Fan Speeds		3	3	3
Airflow (lowest to highest)	cfm	700/910/1,080	720/1,030/1,230	1,260/1,710/2,150
Sound Pressure (lowest to highest)	dB(A)	38.5/42/45.5	46/49.5/50.5	51/54/57
Max Static Pressure	in W.C.	0.64	0.64	0.80
Field Drain Pipe Size O.D.	in (mm)	1 (25.4)	1 (25.4)	1 (25.4)

Performance may vary based on the compatible outdoor units. See respective pages for performance data.

COMPATIBILITY:

Indoor Unit	40MBDQ36---3	40MBDQ48---3	40MBDQ58---3
Outdoor Unit Single Zone	38MBRBQ36A--3	38MBRBQ48A--3	38MBRBQ58A--3

Backward compatible with 38MBQ Single Zone Systems.

PERFORMANCE™ SERIES
40MBFQ CONSOLE



Performance™ Floor Console Indoor Unit

FEATURES OUTDOOR

- Modes: Cool, Heat, Dry, Fan, Auto
- Auto-restart function
- Capable to be mounted on floor and ceiling
- Louver control (fixed or swing)
- Three fan speeds
- *Follow Me* (senses temperature at handheld remote)
- Heating Setback (46° F Heating Mode)
- Quiet indoor operation, as low as 43 dB(A)
- Anti-corrosive fin coating

COMPATIBLE WITH:

- 38MBR Outdoor Unit Single Zone (p 62)
- 38MBRB Outdoor Unit Single Zone (p 26)



Sizes: 36 / 48 / 58

KEY FEATURES

Outside Air Intake

Outside air is brought into the room via a connection pipe, which keeps the indoor air fresher and cleaner.

Flexible Installation

Can be installed on the floor or ceiling depending on the application need.

CONTROLS

Wireless Remote Controller included with indoor unit

Optional Wired Remote Controller KSACN0101AAA (Timer Function)

Optional Wired Remote Controller KSACN0701AAA (7-Day Programmable)



**Optional
Wired Controller
(7-Day Programmable)
KSACN0701AAA**



**Wireless
Remote
Controller**

ACCESSORIES

Wi-Fi® Smartphone control kit KSAIF0401AAA

24V Interface for third-party thermostat compatibility KSAIC0301230

SPECIFICATIONS:

40MBFQ Console				
Heat Pump				
System				
Size		36	48	58
Indoor Model		40MBFQ36---3	40MBFQ48---3	40MBFQ58---3
Electrical				
Voltage, Phase, Cycle	V/Ph/Hz	208/230-1-60	208/230-1-60	208/230-1-60
Power Supply		Indoor Unit Powered From Outdoor Unit		
MCA	A	1.23	0.85	1.48
Controls				
Wireless Remote Controller (° F / ° C Convertible)		Standard	Standard	Standard
Wired Remote Controller (° F / ° C Convertible)		Optional	Optional	Optional
Operating Range				
Cooling Indoor DB Min - Max	° F (° C)	63~90 (17~32)	63~90 (17~32)	63~90 (17~32)
Heating Indoor DB Min - Max	° F (° C)	32~86 (0~30)	32~86 (0~30)	32~86 (0~30)
Piping				
Pipe Connection Size - Liquid	in (mm)	3/8 (9.52)	3/8 (9.52)	3/8 (9.52)
Pipe Connection Size - Suction	in (mm)	5/8 (16)	5/8 (16)	3/4 (19)
Indoor				
Unit Width	in (mm)	50.59 (1,285)	64.96 (1,650)	64.96 (1,650)
Unit Height	in (mm)	9.25 (235)	9.25 (235)	9.25 (235)
Unit Depth	in (mm)	26.57 (675)	26.57 (675)	26.57 (675)
Net Weight	lb (kg)	69 (31.3)	83.78 (38)	110 (50)
Number of Fan Speeds		3	3	3
Airflow (lowest to highest)	cfm	638/917/1,037	1,000/1,120/1,350	796/1,029/1,385
Sound Pressure (lowest to highest)	dB(A)	43/49/54	52/54/57	46/49/55
Air Throw Data	ft (m)	33 (10)	39 (12)	39 (12)
Field Drain Pipe Size O.D.	in (mm)	1 (25.4)	1 (25.4)	1 (25.4)

Performance may vary based on the compatible outdoor units. See respective pages for performance data.

COMPATIBILITY:

Indoor Unit	40MBFQ36---3	40MBFQ48---3	40MBFQ58---3
Outdoor Unit Single Zone	38MBRBQ36A--3	38MBRBQ48A--3	38MBRBQ58A--3

PERFORMANCE™ SERIES 40MBAA AIR HANDLER



Performance™ Multi-Poise Air Handler

FEATURES

- Modes: Cool, Heat, Dry, Fan, Auto
- Up to 20.0 SEER and 10.4 HSPF based on outdoor unit pairing
- Multi Poise Installation (Up Flow, Down Flow, Horizontal Right, Horizontal Left)
- Total system static pressure up to 0.8 in. W.C.
- Less than 2% air leakage
- Quiet indoor operation
- Built-in third-party thermostat compatibility
- Anti-corrosive fin coating
- Extreme heating operation in as low as -22° F (-30° C) based on outdoor unit pairing
- Optional Electric Heat Packages available (5,10,15 and 20 KW)

COMPATIBLE WITH:

- 38MARB Outdoor Unit Single Zone (p 26)
- 38MGR Outdoor Unit Multi-Zone (p 56)
- 38MBRB Outdoor Unit Single Zone (p 64)

Performance
SERIES

Size: 24 / 36 / 48

Select sizes are ENERGY STAR® certified based on outdoor unit pairing

KEY FEATURES

Installation Flexibility

A built-in multiposition drain allows the unit to be mounted vertically (up flow or down flow) or horizontally (left or right), enabling multi-position installation. All three sizes are capable of operating as traditional central ducted systems when paired with a compatible single zone outdoor unit.

Multi-Zone Compatibility

The size 24 Air Handler can connect to select multi-zone outdoor units to create one integrated system, enabling unique zoned comfort and efficiency.

Efficient Comfort

As an alternate to gas furnaces, reduce the use of fossil fuels and experience cleaner energy and efficiency levels that meet many local and federal requirements.

CONTROLS

Factory installed 24V interface for third-party thermostat compatibility*

Wireless Remote Controller included

ACCESSORIES

Electric Heat Packages EHKMA05KN, EHKMA10KN, EHKMA15KN, EHKMA20KN

Only Size 24 is available for multi-zone applications.

*Note: See installation instructions for details

SPECIFICATIONS:

40MBAA Air Handler				
Heat Pump				
System				
Size		24	36	48
Indoor Model		40MBAAQ24XA3	40MBAAQ36XA3	40MBAAQ48XA3
Electrical				
Voltage-Phase-Cycle	V-Ph-Hz	208/230-1-60	208/230-1-60	208/230-1-60
Power Supply		Indoor Unit Powered From Outdoor Unit		
MCA	A.	5	5	5
Controls				
Wireless Remote Controller (° F/° C Convertible)		Standard	Standard	Standard
Third party thermostat compatibility		Standard	Standard	Standard
Operating Range				
Cooling Indoor DB Min - Max	° F (° C)	62~90 (17~32)	62~90 (17~32)	62~90 (17~32)
Heating Indoor DB Min - Max	° F (° C)	32~86 (0~30)	32~86 (0~30)	32~86 (0~30)
Piping				
Pipe Connection Size - Liquid	in (mm)	3/8 (9.52)	3/8 (9.52)	3/8 (9.52)
Pipe Connection Size - Suction	in (mm)	5/8 (16)	5/8 (16)	5/8 (16)
Indoor				
Unit Width	in (mm)	19.6 (498)	19.6 (498)	19.6 (498)
Unit Height	in (mm)	48.8 (1,240)	48.8 (1,240)	48.8 (1,240)
Unit Depth	in (mm)	21.0 (533)	21.0 (533)	21.0 (533)
Net Weight	lbs (kg)	141.1 (64)	144.8 (65.7)	144.8 (65.7)
Number of Fan Speeds		4	4	4
Airflow (lowest to highest)	CFM	588/765/882	824/1,000/1,176	1,176/1,294/1,412
Sound Pressure - Cooling (lowest to highest)	dB(A)	37.2/40.4/43/45.2	37.2/40.4/43/45.2	37.2/40.4/43/45.2
Sound Pressure - Heating (lowest to highest)		35.8/38.7/41.7	37.9/43/46.5/48	50/51.9/53.9/54.9
Max Static Pressure	In W.C.	0.80	0.80	0.80
Field Drain Pipe Size O.D.	in (mm)	3/4 (19.1)	3/4 (19.1)	3/4 (19.1)

*Performance may vary based on the compatible outdoor units. See respective pages for performance data.

COMPATIBILITY:

Indoor Unit	Outdoor Unit Single Zone			Outdoor Unit Multi-Zone		
	38MARBQ24AA3	38MBRBQ36AA3	38MBRBQ48AA3	38MGRQ30D--3	38MGRQ36D--3	38MGRQ48E--3
40MBAAQ24XA3	•			•	•	•
40MBAAQ36XA3		•				
40MBAAQ48XA3			•			

Manufacturer reserves the right to discontinue, or change at any time, specification or designs without notice or incurring obligations.

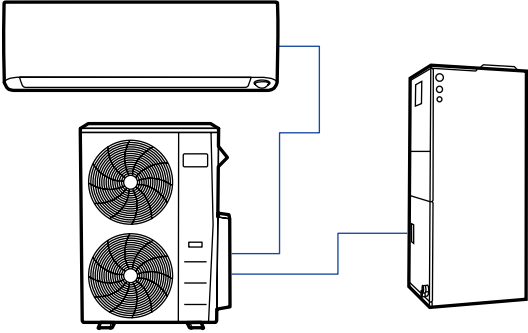

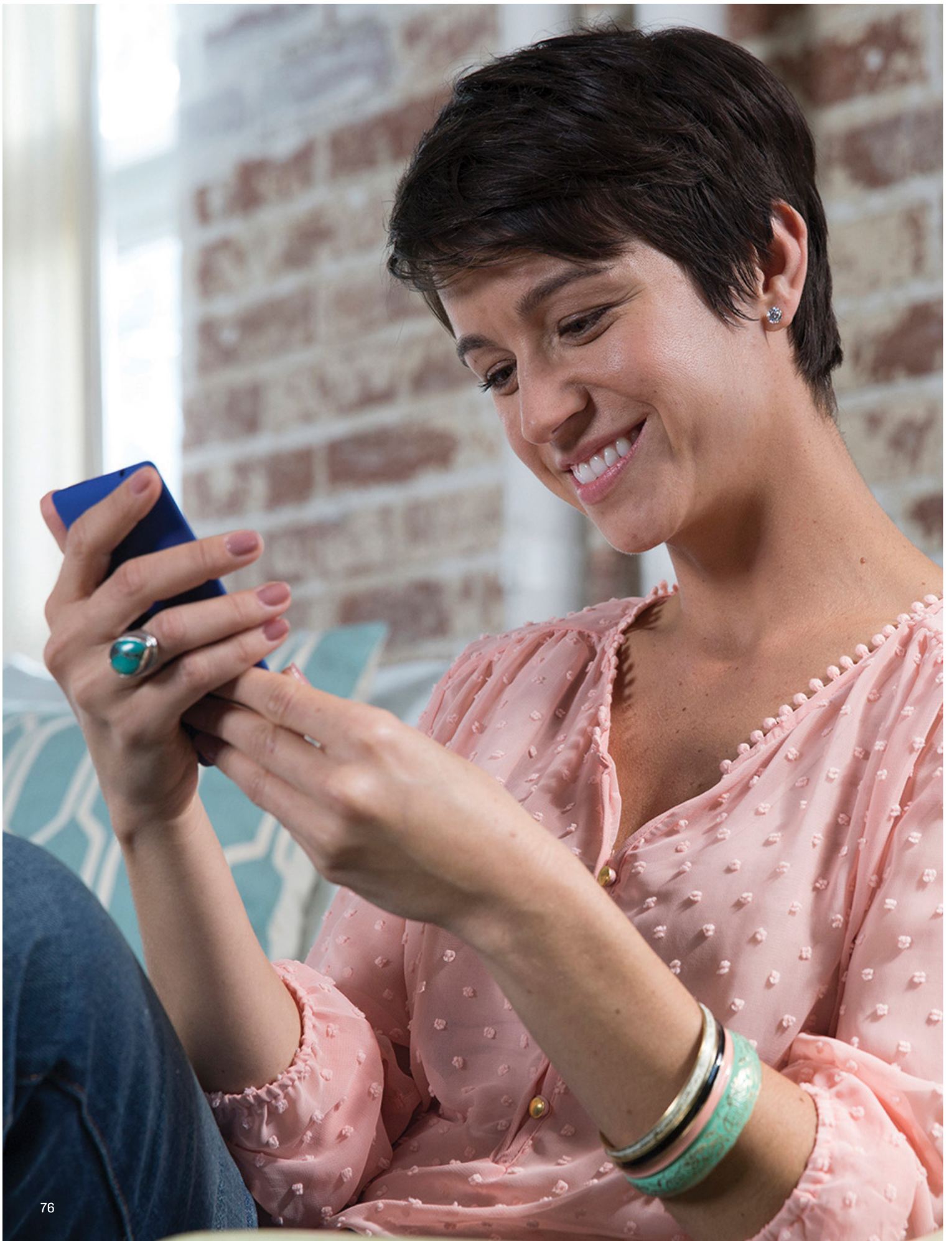



Performance™ Outdoor Unit

FEATURES

- Available in 208/230V-1, 208/230V-3 and 460V-3
- WeatherArmor™ cabinet – All-steel cabinet construction – Mesh coil guard
- Quiet outdoor operation, as low as 66 dB(A)
- Piping length up to 250 ft.
- Cooling operating range -20° ~ 125° F (-28° ~ 52° C) (w/ Low-Ambient Kit)
- Heating operating range 17° ~ 75° F (-8° ~ 24° C)

COMPATIBLE WITH:

- Ducted Indoor Units

Performance
SERIES

Cooling Only – 24AHA4

Heat Pump – 25HHA4

Fixed-Speed Compressor

14.0 SEER

8.2 HSPF

Sizes: 18 / 24 / 30 / 36 / 48 / 60

KEY FEATURES

Longer Piping Lengths

Piping flexibility up to a total piping length of 213 ft. (65m.).

Low Ambient Cooling

With built-in low ambient kit or special designed PCB, outdoor fan speeds can be changed automatically based on the temperature. The unit can run cooling operation even in low ambient temperatures.



Ducted Indoor Units

PERFORMANCE™ SERIES

24AHA4 AND 25HHA4 OUTDOOR UNIT

SPECIFICATIONS:

24AHA4 Outdoor Unit							
Cooling Only System							
Size		18	24	30	36	36	36
Outdoor Model		24AHA418A003	24AHA424A003	24AHA430A003	24AHA436A003	24AHA436A005	24AHA436A006
Electrical							
Outdoor Voltage, Phase, Cycle	V/Ph/Hz	208/230-1-60	208/230-1-60	208/230-1-60	208/230-1-60	208/230-3-60	460-3-60
MCA (Outdoor)	A	11.8	14.1	18.3	18.8	12.5	7.6
MOCP - Fuse Rating (Outdoor)	A	20	25	30	30	20	15
Operating Range							
Cooling Outdoor DB Min - Max	° F	55~125 (-20° F w/ Low-Ambient Kit)					
Piping							
Total Piping Length	ft	200	200	200	200	200	200
Drop (OD above ID)	ft	200	200	200	200	200	200
Lift (OD below ID)	ft	65	65	65	65	65	65
Outdoor Pipe Connection Size - Liquid	in	3/8	3/8	3/8	3/8	3/8	3/8
Outdoor Pipe Connection Size - Suction	in	5/8	3/4	3/4	7/8	7/8	7/8
Refrigerant							
Type		R410A	R410A	R410A	R410A	R410A	R410A
Charge	lb	6.4	6.5	8.6	8.9	8.9	8.9
Compressor							
Type		Scroll	Scroll	Scroll	Scroll	Scroll	Scroll
Outdoor							
Unit Width	in	36.9	36.9	44.5	44.5	44.5	44.5
Unit Height	in	31.1	31.1	37.1	37.1	37.1	37.1
Unit Depth	in	14.6	14.6	17.1	17.1	17.1	17.1
Net Weight	lb	146	148	183	184	184	184
Airflow	cfm	1,285	1,285	1,900	2,615	2,615	2,615
Nominal Performance Ducted Fan Coils							
Indoor Model		*	*	*	*	*	*
ENERGY STAR®		NO	NO	NO	NO	NO	NO
Cooling System Tons		1.5	2.0	2.5	3.0	3.0	3.0
Cooling Rated Capacity (Nominal)	Btu/h	18,000	24,000	29,600	35,400	35,400	35,400
SEER		14.0	14.0	14.0	14.0	14.0	14.0
EER		12.2	12.2	12.2	12.2	12.2	12.2

Tested AHRI Combination Ratings

Additional ratings and system combinations can be accessed via the Carrier database at: MyCarrierRatings.com

*For performance data at specific application and/or design conditions with various indoor unit combinations, the equipment performance calculator can be accessed at: <http://rpmob.wrightsoft.com/>

PERFORMANCE™ SERIES
24AHA4 AND 25HHA4 OUTDOOR UNIT

SPECIFICATIONS:

24AHA4 Outdoor Unit							
Cooling Only System							
Size		48	48	48	60	60	60
Outdoor Model		24AHA448A003	24AHA448A005	24AHA448A006	24AHA460A003	24AHA460A005	24AHA460A006
Electrical							
Outdoor Voltage, Phase, Cycle	V/Ph/Hz	208/230-1-60	208/230-3-60	460-3-60	208/230-1-60	208/230-3-60	460-3-60
MCA (Outdoor)	A	24.3	18.3	8.4	31.1	21.4	9.7
MOCP - Fuse Rating (Outdoor)	A	40	30	15	50	35	15
Operating Range							
Cooling Outdoor DB Min - Max	° F	55~125 (-20° F w/ Low-Ambient Kit)					
Piping							
Total Piping Length	ft	200	200	200	200	200	200
Drop (OD above ID)	ft	200	200	200	200	200	200
Lift (OD below ID)	ft	65	65	65	65	65	65
Outdoor Pipe Connection Size - Liquid	in	3/8	3/8	3/8	3/8	3/8	3/8
Outdoor Pipe Connection Size - Suction	in	7/8	7/8	7/8	1 1/8	1 1/8	1 1/8
Refrigerant							
Type		R410A	R410A	R410A	R410A	R410A	R410A
Charge	lb	9	9	9	10.6	10.6	10.6
Compressor							
Type		Scroll	Scroll	Scroll	Scroll	Scroll	Scroll
Outdoor							
Unit Width	in	44.5	44.5	44.5	44.5	44.5	44.5
Unit Height	in	37.1	37.1	37.1	43.1	43.1	43.1
Unit Depth	in	17.1	17.1	17.1	17.1	17.1	17.1
Net Weight	lb	213	213	213	245	245	245
Airflow	cfm	2,615	2,615	2,615	2,785	2,785	2,785
Nominal Performance Ducted Fan Coils							
Indoor Model		*	*	*	*	*	*
ENERGY STAR®		NO	NO	NO	NO	NO	NO
Cooling System Tons		3.8	3.8	3.8	4.8	4.8	4.8
Cooling Rated Capacity (Nominal)	Btu/h	45,000	45,000	45,000	57,000	57,000	57,000
SEER		14.0	14.0	14.0	14.0	14.0	14.0
EER		11.7	11.7	11.7	11.7	11.7	11.7

Tested AHRI Combination Ratings

Additional ratings and system combinations can be accessed via the Carrier database at: www.MyCarrierRatings.com

*For performance data at specific application and/or design conditions with various indoor unit combinations, the equipment performance calculator can be accessed at: <http://rpmob.wrightsoft.com/>

PERFORMANCE™ SERIES

24AHA4 AND 25HHA4 OUTDOOR UNIT

SPECIFICATIONS:

25HHA4 Outdoor Unit							
Heat Pump							
System							
Size		18	24	30	36	36	36
Outdoor Model		25HHA418A003	25HHA424A003	25HHA430A003	25HHA436A003	25HHA436A005	25HHA436A006
Electrical							
Outdoor Voltage, Phase, Cycle	V/Ph/Hz	208/230-1-60	208/230-1-60	208/230-1-60	208/230-1-60	208/230-3-60	460-3-60
MCA (Outdoor)		11.8	16.5	17.2	19	12.8	7.6
MOCP - Fuse Rating (Outdoor)		20	25	30	30	20	15
Operating Range							
Cooling Outdoor DB Min–Max	° F	55~125 (-20° F w/ Low-Ambient Kit)					
Heating Outdoor DB Min - Max	° F	17~75	17~75	17~75	17~75	17~75	17~75
Piping							
Total Piping Length	ft	200	200	200	200	200	200
Drop (OD above ID)	ft	200	200	200	200	200	200
Lift (OD below ID)	ft	65	65	65	65	65	65
Outdoor Pipe Connection Size - Liquid	in	3/8	3/8	3/8	3/8	3/8	3/8
Outdoor Pipe Connection Size - Suction	in	5/8	3/4	3/4	7/8	7/8	7/8
Refrigerent							
Type		R410A	R410A	R410A	R410A	R410A	R410A
Charge	lb	6.72	7.67	12.1	12.3	12.3	12.3
Compressor							
Type		Scroll	Scroll	Scroll	Scroll	Scroll	Scroll
Outdoor							
Unit Width	in	36.9	36.9	44.5	44.5	44.5	44.5
Unit Height	in	25.1	31.1	37.1	37.1	37.1	37.1
Unit Depth	in	14.6	14.6	17.1	17.1	17.1	17.1
Net Weight	lb	150	161	196	197	197	197
Airflow	cfm	1,285	1,285	2,615	2,615	2,615	2,615
Nominal Performance Ducted Fan Coils							
Indoor Model		*	*	*	*	*	*
ENERGY STAR®		NO	NO	NO	NO	NO	NO
Cooling System Tons		1.5	2.0	2.4	2.9	2.9	2.9
Cooling Rated Capacity	Btu/h	18,000	23,400	28,800	34,200	34,200	34,200
SEER		14.0	14.0	14.0	14.0	14.0	14.0
EER		11.5	11.5	12.5	12.0	12.0	11.5
Heating Rated Capacity	Btu/h	17,200	22,800	28,200	34,200	34,200	34,200
HSPF		8.2	8.2	8.5	8.5	8.5	8.2
COP	W/W	2.48	2.5	2.62	2.6	2.6	2.6

Tested AHRI Combination Ratings

Additional ratings and system combinations can be accessed via the Carrier database at: www.MyCarrierRatings.com

*For performance data at specific application and/or design conditions with various indoor unit combinations, the equipment performance calculator can be accessed at: <http://rpmob.wrightsoft.com/>

PERFORMANCE™ SERIES
24AHA4 AND 25HHA4 OUTDOOR UNIT

SPECIFICATIONS:

25HHA4 Outdoor Unit							
Heat Pump							
System							
Size		48	48	48	60	60	60
Outdoor Model		25HHA448A003	25HHA448A005	25HHA448A006	25HHA460A003	25HHA460A005	25HHA460A006
Electrical							
Outdoor Voltage, Phase, Cycle	V/Ph/Hz	208/230-1-60	208/230-3-60	460-3-60	208/230-1-60	208/230-3-60	460-3-60
MCA (Outdoor)	A	28.8	18.6	8.6	33.4	22.9	10.6
MOCP - Fuse Rating (Outdoor)	A	50	30	15	50	40	15
Operating Range							
Cooling Outdoor DB Min - Max	° F	55~125 (-20° F w/ Low-Ambient Kit)					
Heating Outdoor DB Min - Max	° F	17~75	17~75	17~75	17~75	17~75	17~75
Piping							
Total Piping Length	ft	200	200	200	200	200	200
Drop (OD above ID)	ft	200	200	200	200	200	200
Lift (OD below ID)	ft	65	65	65	65	65	65
Outdoor Pipe Connection Size - Liquid	in	3/8	3/8	3/8	3/8	3/8	3/8
Outdoor Pipe Connection Size - Suction	in	7/8	7/8	7/8	1 1/8	1 1/8	1 1/8
Refrigerent							
Type		R410A	R410A	R410A	R410A	R410A	R410A
Charge	lb	10.95	10.95	10.95	11.82	11.82	11.82
Compressor							
Type		Scroll	Scroll	Scroll	Scroll	Scroll	Scroll
Outdoor							
Unit Width	in	44.5	44.5	44.5	44.5	44.5	44.5
Unit Height	in	43.1	43.1	43.1	43.1	43.1	43.1
Unit Depth	in	17.1	17.1	17.1	17.1	17.1	17.1
Net Weight	lb	246	246	246	258	258	258
Airflow	cfm	2,785	2,785	2,785	2,785	2,785	2,785
Nominal Performance Ducted Fan Coils							
Indoor Model		*	*	*	*	*	*
ENERGY STAR®		NO	NO	NO	NO	NO	NO
Cooling System Tons		3.8	3.8	3.8	4.6	4.6	4.6
Cooling Rated Capacity	Btu/h	45,500	45,500	45,500	55,000	55,000	55,000
SEER		14.0	14.0	14.0	14.0	14.0	14.0
EER		11.5	11.5	11.5	11.5	11.5	11.5
Heating Rated Capacity	Btu/h	46,000	46,000	46,000	55,000	55,000	55,000
HSPF		8.2	8.2	8.2	8.2	8.2	8.2
COP	W/W	2.56	2.56	2.56	2.62	2.62	2.62

Tested AHRI Combination Ratings

Additional ratings and system combinations can be accessed via the Carrier database at: www.MyCarrierRatings.com

*For performance data at specific application and/or design conditions with various indoor unit combinations, the equipment performance calculator can be accessed at: <http://rpmob.wrightsoft.com/>

TOSHIBA CARRIER SERIES
RAV*AT OUTDOOR UNIT



Toshiba Carrier Light Commercial Heat Pump

FEATURES

- Available in 208/230V
- Quiet outdoor operation, as low as 48 dB(A)
- Piping length 165 ~ 245 ft.
- Cooling operating range
0° ~ 110° F (-17° ~ 44° C)
(w/wind baffles) – Sizes 18 & 24
-13° ~ 110° F (-25° ~ 44° C)
(w/wind baffles) – Sizes 36 & 42
- Heating operating range
-4° ~ 59° F (-20° ~ 15° C)

Systems can be programmed to operate in cooling-only mode with heating locked out.

COMPATIBLE WITH:

- RAV*KRT High Wall (p 86)
- RAV*UT Cassette (p 88)
- RAV*BT Ducted (p 90)
- RAV*CT Underceiling (p 92)

Inverter Compressor

Up to 21.0 SEER

Up to 12.0 HSPF

Sizes: 18 / 24 / 30 / 36 / 42



High Wall



Cassette



Ducted



Console



SPECIFICATIONS:

RAV*AT Outdoor Unit						
Heat Pump						
System						
Size		18	24	30	36	42
Outdoor Model		RAV-SP180AT2-UL	RAV-SP240AT2-UL	RAV-SP300AT2-UL	RAV-SP360AT2-UL	RAV-SP420AT2-UL
Electrical						
Voltage, Phase, Cycle	V/Ph/Hz	208/230-1-60	208/230-1-60	208/230-1-60	208/230-1-60	208/230-1-60
MCA	A	17	24	24	24	24
MOCP - Fuse Rating	A	30	40	40	40	40
Operating Range						
Cooling Outdoor DB Min - Max	° F (° C)	23~110 (-5~44) [0 (-17) with wind baffle]		23~110 (-5~44) [-13 (-25) with wind baffle]		
Heating Outdoor DB Min - Max	° F (° C)	-4~59 (-20~15)	-4~59 (-20~15)	-4~59 (-20~15)	-4~59 (-20~15)	-4~59 (-20~15)
Piping						
Total Piping Length	ft (m)	165 (50.2)	165 (50.2)	245 (74.7)	245 (74.7)	245 (74.7)
Piping Lift*	ft (m)	100 (30.5)	100 (30.5)	100 (30.5)	100 (30.5)	100 (30.5)
Pipe Connection Size - Liquid	in (mm)	1/4 (6.35)	3/8 (9.52)	3/8 (9.52)	3/8 (9.52)	3/8 (9.52)
Pipe Connection Size - Suction	in (mm)	1/2 (12.7)	5/8 (16)	5/8 (16)	5/8 (16)	5/8 (16)
Refrigerant						
Type		R410A	R410A	R410A	R410A	R410A
Charge	lb (kg)	3.1	4.6	6.8	6.8	6.8
Compressor						
Type		Rotary Inverter	Rotary Inverter	Rotary Inverter	Rotary Inverter	Rotary Inverter
Outdoor						
Unit Width	in (mm)	30.7 (779)	35.4 (899)	35.4 (899)	35.4 (899)	35.4 (899)
Unit Height	in (mm)	21.7 (551)	35 (889)	52.8 (1,341)	52.8 (1,341)	52.8 (1,341)
Unit Depth	in (mm)	11.4 (289)	12.6 (289)	12.6 (320)	12.6 (320)	12.6 (320)
Net Weight	lb (kg)	98 (44.4)	144.5 (65.5)	211.5 (95.9)	211.5 (95.9)	211.5 (95.9)
Sound Pressure	dB(A)	48/49	49/50	50/51	52/52	52/52

*Condensing unit above or below indoor unit.

COMPATIBILITY:

Indoor Unit		Outdoor Unit				
		RAV-SP180AT2-UL	RAV-SP240AT2-UL	RAV-SP300AT2-UL	RAV-SP360AT2-UL	RAV-SP420AT2-UL
High Wall	RAV-SP180KRT-UL	•				
	RAV-SP240KRT-UL		•			
Cassette	RAV-SP180UT-UL	•				
	RAV-SP240UT-UL		•			
	RAV-SP300UT-UL			•		
	RAV-SP360UT-UL				•	
	RAV-SP420UT-UL					•
Ducted	RAV-SP181BT-UL	•				
	RAV-SP241BT-UL		•			
	RAV-SP301BT-UL			•		
	RAV-SP361BT-UL				•	
	RAV-SP421BT-UL					•
Underceiling	RAV-SP180CT-UL	•				
	RAV-SP240CT-UL		•			
	RAV-SP300CT-UL			•		
	RAV-SP360CT-UL				•	
	RAV-SP420CT-UL					•

TOSHIBA CARRIER SERIES

RAV*AT OUTDOOR UNIT

PERFORMANCE:

RAV*KRT High Wall			
Indoor Model		RAV-SP180KRT-UL	RAV-SP240KRT-UL
ENERGY STAR®		NO	NO
High Wall			
Cooling System Tons		1.5	2.1
Cooling Rated Capacity	Btu/h	18,000	25,000
Cooling Cap. Range Min - Max	Btu/h	3,560~23,500	4,100~32,600
SEER		19.5	16.7
EER		10.0	9.1
Heating Rated Capacity (47° F)	Btu/h	19,000	26,400
Heating Rated Capacity (17° F)	Btu/h	11,600	16,720
Heating Maximum Capacity (17° F)	Btu/h	16,500	24,500
Heating Maximum Capacity (5° F)	Btu/h	11,600	16,900
Heating Cap. Range Min - Max	Btu/h	2,250~23,000	3,480~30,400
HSPF		11.5	9.8
COP (47° F)	W/W	3.12	2.70
COP (17° F)	W/W	2.09	2.02
COP (5° F)	W/W	1.80	1.76

PERFORMANCE:

RAV*UT Cassette						
Indoor Model		RAV-SP180UT-UL	RAV-SP240UT-UL	RAV-SP300UT-UL	RAV-SP360UT-UL	RAV-SP420UT-UL
ENERGY STAR®		NO	NO	YES	YES	NO
Cassette						
Cooling System Tons		1.6	2.1	2.7	3.0	3.4
Cooling Rated Capacity	Btu/h	19,000	25,000	32,000	36,500	40,800
Cooling Cap. Range Min - Max	Btu/h	3,800~21,600	5,670~28,500	10,470~36,460	11,260~41,500	10,990~46,100
SEER		20.5	20.7	21.0	21.0	19.0
EER		10.7	11.0	14.0	13.0	11.5
Heating Rated Capacity (47° F)	Btu/h	18,800	26,000	33,400	36,000	46,000
Heating Rated Capacity (17° F)	Btu/h	11,100	15,390	19,280	22,800	24,420
Heating Maximum Capacity (17° F)	Btu/h	16,400	24,200	27,300	32,000	34,400
Heating Maximum Capacity (5° F)	Btu/h	11,300	15,800	18,700	22,400	24,600
Heating Cap. Range Min - Max	Btu/h	3,100~21,200	4,100~29,900	8,500~38,100	8,240~40,300	8,400~51,500
HSPF		12.0	10.0	11.0	12.0	11.0
COP (47° F)	W/W	3.73	3.36	4.24	4.00	3.51
COP (17° F)	W/W	2.62	2.43	2.90	2.82	2.84
COP (5° F)	W/W	2.21	2.12	2.04	2.04	2.43

PERFORMANCE:

RAV*BT Ducted						
Indoor Model		RAV-SP181BT-UL	RAV-SP241BT-UL	RAV-SP301BT-UL	RAV-SP361BT-UL	RAV-SP421BT-UL
ENERGY STAR®		NO	NO	YES	YES	NO
Ducted						
Cooling System Tons		1.5	2.0	2.5	3.0	3.5
Cooling Rated Capacity	Btu/h	18,000	24,000	30,000	36,000	42,000
Cooling Cap. Range Min - Max	Btu/h	9,600~19,200	14,000~25,800	18,000~32,500	20,800~39,200	23,700~45,400
SEER		17.0	18.2	20.0	19.7	18.7
EER		8.6	9.6	13.0	12.5	10.6
Heating Rated Capacity (47° F)	Btu/h	20,000	27,000	34,000	40,000	47,500
Heating Rated Capacity (17° F)	Btu/h	11,000	19,800	20,700	21,500	32,300
Heating Maximum Capacity (17° F)	Btu/h	12,400	16,740	21,080	24,800	29,450
Heating Maximum Capacity (5° F)	Btu/h	9,400	12,690	15,980	18,800	22,325
Heating Cap. Range Min - Max	Btu/h	11,000~22,500	19,800~30,800	20,700~35,000	21,500~41,500	32,300~49,000
HSPF		10.8	9.6	11.8	11.5	12.0
COP (47° F)	W/W	2.85	2.89	3.75	3.69	3.25
COP (17° F)	W/W	2.19	2.24	2.89	2.86	2.51
COP (5° F)	W/W	1.85	1.87	2.43	2.40	2.11

PERFORMANCE:

RAV*CT Underceiling						
Indoor Model		RAV-SP180CT-UL	RAV-SP240CT-UL	RAV-SP300CT-UL	RAV-SP360CT-UL	RAV-SP420CT-UL
ENERGY STAR®		NO	NO	YES	NO	NO
Underceiling						
Cooling System Tons		1.4	2.0	2.5	3.0	3.4
Cooling Rated Capacity	Btu/h	17,000	23,700	30,000	36,000	41,000
Cooling Cap. Range Min - Max	Btu/h	3,750~19,400	4,700~26,900	11,340~34,200	11,960~41,000	10,980~46,700
SEER		17.0	19.5	20.6	20.4	18.8
EER		8.6	9.0	13.0	12.0	9.7
Heating Rated Capacity (47° F)	Btu/h	19,000	28,900	29,800	38,000	44,800
Heating Rated Capacity (17° F)	Btu/h	17,405	18,930	21,710	25,280	28,100
Heating Maximum Capacity (17° F)	Btu/h	17,600	28,000	36,100	36,100	39,200
Heating Maximum Capacity (5° F)	Btu/h	12,700	19,700	23,500	23,500	26,700
Heating Cap. Range Min - Max	Btu/h	2,800~21,700	3,600~32,400	9,900~33,700	11,700~42,750	9,100~50,500
HSPF		10.8	10.3	10.3	11.0	11.0
COP (47° F)	W/W	2.98	2.89	3.99	3.56	3.27
COP (17° F)	W/W	2.85	2.46	3.30	2.76	2.74
COP (5° F)	W/W	2.12	1.77	1.96	1.96	2.35

TOSHIBA CARRIER SERIES
RAV*KRT HIGH WALL



Toshiba Carrier High Wall Indoor Unit

FEATURES

- Available in 208/230V
- Modes: Cool, Heat, Dry, Fan, Auto
- Turbo Mode
- One-touch memory
- Sleep Mode
- Filter maintenance indicator
- Quiet indoor operation, as low as 38 dB(A)

COMPATIBLE WITH:

- RAV*AT Outdoor Unit Single Zone

(p 82)



Sizes: 18 / 24

CONTROLS

Wireless Remote Controller included with indoor unit
Optional Wired Remote Controller



**Optional
Wired Controller
(7-Day Programmable)
RBC-AMS54E-UL**



**Standard
Wireless
Controller**

ACCESSORIES

- Condensate Pump (230V optional)
- Insulated 25' Line Set

Systems can be programmed to operate in cooling-only mode with heating locked out.

SPECIFICATIONS:

RAV*KRT High Wall			
Heat Pump			
System			
Size		18	24
Indoor Model		RAV-SP180KRT-UL	RAV-SP240KRT-UL
Electrical			
Voltage		208/230-1-60	208/230-1-60
Power Supply		Indoor Unit Powered From Outdoor Unit	
Controls			
Wireless (° C, ° F, Convertible)		Standard - Convertible	
Wired (° C, ° F, Convertible)		Optional - Convertible	
Operating Range			
Cooling Indoor DB Min - Max	° F (° C)	69~90 (21~32)	
Heating Indoor DB Min - Max	° F (° C)	59~83 (15~28)	
Piping			
Pipe Connection Size - Liquid	in (mm)	1/4 (6.35)	3/8 (9.52)
Pipe Connection Size - Suction	in (mm)	1/2 (12.7)	5/8 (16)
Indoor			
Unit Width	in (mm)	41.3 (1,049)	41.3 (1,049)
Unit Height	in (mm)	12.6 (320)	12.6 (320)
Unit Depth	in (mm)	9 (228)	9 (228)
Net Weight	lb (kg)	31 (14)	31 (14)
Number of Fan Speeds		3	3
Airflow (lowest to highest)	cfm	400/430/490	401/460/560
Sound Pressure (lowest to highest)	dB(A)	38/41/43	38/41/46

Performance may vary based on the compatible outdoor units. See respective pages for performance data.

COMPATIBILITY:

Indoor Unit	RAV-SP180KRT-UL	RAV-SP240KRT-UL
Outdoor Unit Single Zone	RAV-SP180AT2-UL	RAV-SP240AT2-UL

TOSHIBA CARRIER SERIES
RAV*UT CASSETTE



Toshiba Carrier Cassette Indoor Unit

FEATURES

- Available in 208/230V
- Modes: Cool, Heat, Dry, Fan, Auto
- One-touch memory
- Sleep Mode
- Filter maintenance indicator
- Built-in condensate lift pump
- Outside air intake
- Branch duct capability
- Independent louver control (fixed or swing)
- Power-saving Mode
- Quiet indoor operation, as low as 32 dB(A)

COMPATIBLE WITH:

- RAV*AT Outdoor Unit Single Zone

(p 82)



Sizes: 18 / 24 / 30 / 36 / 42

CONTROLS

Controller not included with indoor unit. Must order:



Optional Wireless Remote Controller

Optional Wired Remote Controller



**Optional
Wired Controller
(7-Day Programmable)
RBC-AMS54E-UL**

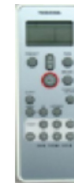

**Standard
Wireless
Controller**

ACCESSORIES

Condensate Pump (230V optional)

Insulated 25' Line Set

Outside air intake

Air-discharge direction kit

Systems can be programmed to operate in cooling-only mode with heating locked out

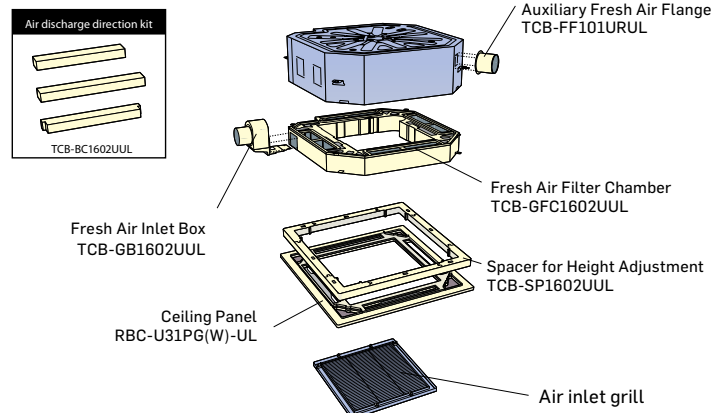

SPECIFICATIONS:

RAV*UT Cassette						
Heat Pump						
System						
Size		18	24	30	36	42
Indoor Model		RAV-SP180UT-UL	RAV-SP240UT-UL	RAV-SP300UT-UL	RAV-SP360UT-UL	RAV-SP420UT-UL
Electrical						
Voltage		208/230-1-60	208/230-1-60	208/230-1-60	208/230-1-60	208/230-1-60
Power Supply		Indoor Unit Powered From Outdoor Unit				
Controls						
Wireless (° C, ° F, Convertible)		Optional - Dedicated ° F or ° C				
Wired (° C, ° F, Convertible)		Optional - Convertible				
Operating Range						
Cooling Indoor DB Min - Max	° F (° C)	69~90 (21~32)	69~90 (21~32)	69~90 (21~32)	69~90 (21~32)	69~90 (21~32)
Heating Indoor DB Min - Max	° F (° C)	59~83 (15~28)	59~83 (15~28)	59~83 (15~28)	59~83 (15~28)	59~83 (15~28)
Piping						
Pipe Connection Size - Liquid	in (mm)	1/4 (6.35)	3/8 (9.52)	3/8 (9.52)	3/8 (9.52)	3/8 (9.52)
Pipe Connection Size - Suction	in (mm)	1/2 (12.7)	5/8 (16)	5/8 (16)	5/8 (16)	5/8 (16)
Indoor						
Unit Width	in (mm)	33.1 (840)	33.1 (840)	33.1 (840)	33.1 (840)	33.1 (840)
Unit Height	in (mm)	10.1 (256)	10.1 (256)	12.6 (320)	12.6 (320)	12.6 (320)
Unit Depth	in (mm)	33.1 (840)	33.1 (840)	33.1 (840)	33.1 (840)	33.1 (840)
Net Weight	lb (kg)	44 (19.9)	44 (19.9)	53 (24)	53 (24)	53 (24)
Grille Dimensions (W X H X D)	in (mm)	37.4 x 1.2 x 37.4 (949 x 30 x 949)				
Grille Net Weight	lb (kg)	10 (4.5)				
Number of Fan Speeds		3	3	3	3	3
Airflow (lowest to highest)	cfm	450/500/600	460/550/700	670/820/1150	700/820/1200	700/820/1200
Sound Pressure (lowest to highest)	dB(A)	34/35/37	34/35/39	36/40/46	38/41/47	38/41/47

Performance may vary based on the compatible outdoor units. See respective pages for performance data.

COMPATIBILITY:

Indoor Unit	RAV-SP180UT-UL	RAV-SP240UT-UL	RAV-SP300UT-UL	RAV-SP360UT-UL	RAV-SP420UT-UL
Outdoor Unit Single Zone	RAV-SP180AT2-UL	RAV-SP240AT2-UL	RAV-SP300AT2-UL	RAV-SP360AT2-UL	RAV-SP420AT2-UL

TOSHIBA CARRIER SERIES
RAV*BT DUCTED STYLE



Toshiba Carrier Ducted Indoor Unit

FEATURES

- Available in 208/230V
- Modes: Cool, Heat, Dry, Fan, Auto
- Up to 0.46 in W.C.
- Rear or bottom return
- Outside air intake
- Built-in condensate lift pump
- Quiet indoor operation, as low as 30 dB(A)

COMPATIBLE WITH:

- RAV*AT Outdoor Unit
Single Zone

(p 82)



Sizes: 18 / 24 / 30 / 36 / 42

CONTROLS

Controller not included with indoor unit. Must order:



Optional Wireless Remote Controller

Optional Wired Remote Controller



**Optional
Wired Controller
(7-Day Programmable)
RBC-AMS54E-UL**



**Optional
Wireless
Controller**

ACCESSORIES

Condensate Pump (208–230V optional)

Systems can be programmed to operate in cooling-only mode with heating locked out.

SPECIFICATIONS:

RAV*BT Ducted Style						
Heat Pump						
System						
Size		18	24	30	36	42
Indoor Model		RAV-SP181BT-UL	RAV-SP241BT-UL	RAV-SP301BT-UL	RAV-SP361BT-UL	RAV-SP421BT-UL
Electrical						
Voltage		208/230-1-60	208/230-1-60	208/230-1-60	208/230-1-60	208/230-1-60
Power Supply		Indoor Unit Powered From Outdoor Unit				
Controls						
Wireless (° C, ° F, Convertible)		Optional - Dedicated ° F or ° C				
Wired (° C, ° F, Convertible)		Optional - Convertible				
Operating Range						
Cooling Indoor DB Min - Max	° F (° C)	69~90 (21~32)	69~90 (21~32)	69~90 (21~32)	69~90 (21~32)	69~90 (21~32)
Heating Indoor DB Min - Max	° F (° C)	59~83 (15~28)	59~83 (15~28)	59~83 (15~28)	59~83 (15~28)	59~83 (15~28)
Piping						
Pipe Connection Size - Liquid	in (mm)	1/4 (6.35)	3/8 (9.52)	3/8 (9.52)	3/8 (9.52)	3/8 (9.52)
Pipe Connection Size - Suction	in (mm)	1/2 (12.7)	5/8 (16)	5/8 (16)	5/8 (16)	5/8 (16)
Indoor						
Unit Width	in (mm)	12.6 (320)	12.6 (320)	12.6 (320)	12.6 (320)	12.6 (320)
Unit Height	in (mm)	27.6 (700)	39.4 (1,000)	53.2 (1,350)	53.2 (1,350)	53.2 (1,350)
Unit Depth	in (mm)	31.5 (800)	31.5 (800)	31.5 (800)	31.5 (800)	31.5 (800)
Net Weight	lb (kg)	73 (33)	93 (42)	119 (54)	119 (54)	119 (54)
Number of Fan Speeds		3	3	3	3	3
Airflow (lowest to highest)	cfm	341/406/459	529/618/706	765/853/953	929/1,041/1,165	929/1,041/1,165
Sound Pressure (lowest to highest)	dB(A)	30/33/36	32/34/36	33/36/39	34/37/40	34/37/40
Max Static Pressure	in W.C.	0.45	0.45	0.46	0.46	0.46
Field Drain Pipe Size O.D.	in (mm)	1 (25.4)	1 (25.4)	1 (25.4)	1 (25.4)	1 (25.4)

Performance may vary based on the compatible outdoor units. See respective pages for performance data.

COMPATIBILITY:

Indoor Unit	RAV-SP181BT-UL	RAV-SP241BT-UL	RAV-SP301BT-UL	RAV-SP361BT-UL	RAV-SP421BT-UL
Outdoor Unit Single Zone	RAV-SP180AT2-UL	RAV-SP240AT2-UL	RAV-SP300AT2-UL	RAV-SP360AT2-UL	RAV-SP420AT2-UL

TOSHIBA CARRIER SERIES
RAV*CT UNDERCEILING



Toshiba Carrier Underceiling Indoor Unit

FEATURES

- Available in 208/230V
- Modes: Cool, Heat, Dry, Fan, Auto
- Outside air intake
- Power-saving Mode
- Filter maintenance indicator
- Quiet indoor operation, as low as 34 dB(A)

COMPATIBLE WITH:

- RAV*AT Outdoor Unit Single Zone

(p 82)



Sizes: 18 / 24 / 30 / 36 / 42

CONTROLS

Controller not included with indoor unit. Must order:



Optional Wireless Remote Controller

Optional Wired Remote Controller



Optional Wired Controller (7-Day Programmable) RBC-AMS54E-UL



Optional Wireless Controller

ACCESSORIES

Condensate Pump (208–230V optional)

Elbow Piping Kit

Systems can be programmed to operate in cooling-only mode with heating locked out

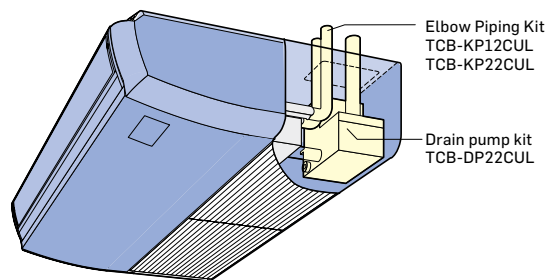

SPECIFICATIONS:

RAV*CT Underceiling						
Heat Pump						
System						
Size		18	24	30	36	42
Indoor Model		RAV-SP180CT-UL	RAV-SP240CT-UL	RAV-SP300CT-UL	RAV-SP360CT-UL	RAV-SP420CT-UL
Electrical						
Voltage		208/230-1-60	208/230-1-60	208/230-1-60	208/230-1-60	208/230-1-60
Power Supply		Indoor Unit Powered From Outdoor Unit				
Controls						
Wireless (° C, ° F, Convertible)		Optional – Dedicated ° F or ° C				
Wired (° C, ° F, Convertible)		Optional – Convertible				
Operating Range						
Cooling Indoor DB Min - Max	° F (° C)	69~90 (21~32)	69~90 (21~32)	69~90 (21~32)	69~90 (21~32)	69~90 (21~32)
Heating Indoor DB Min - Max	° F (° C)	59~83 (15~28)	59~83 (15~28)	59~83 (15~28)	59~83 (15~28)	59~83 (15~28)
Piping						
Pipe Connection Size - Liquid	in (mm)	1/4 (6.35)	3/8 (9.52)	3/8 (9.52)	3/8 (9.52)	3/8 (9.52)
Pipe Connection Size - Suction	in (mm)	1/2 (12.7)	5/8 (16)	5/8 (16)	5/8 (16)	5/8 (16)
Indoor						
Unit Width	in (mm)	35.8 (909)	46.5 (1,181)	62.8 (1,595)	62.8 (1,595)	62.8 (1,595)
Unit Height	in (mm)	8.3 (210)	8.3 (210)	8.3 (210)	8.3 (210)	8.3 (210)
Unit Depth	in (mm)	26.8 (680)	26.8 (680)	26.8 (680)	26.8 (680)	26.8 (680)
Net Weight	lb (kg)	46 (20.8)	55 (24.9)	73 (33.1)	73 (33.1)	73 (33.1)
Number of Fan Speeds		3	3	3	3	3
Airflow (lowest to highest)	cfm	320/360/410	470/530/590	660/750/860	730/820/950	730/820/950
Sound Pressure (lowest to highest)	dB(A)	34/37/40	37/40/42	38/42/45	40/44/47	40/44/47

Performance may vary based on the compatible outdoor units. See respective pages for performance data.

COMPATIBILITY:

Indoor Unit	RAV-SP180CT-UL	RAV-SP240CT-UL	RAV-SP300CT-UL	RAV-SP360CT-UL	RAV-SP420CT-UL
Outdoor Unit Single Zone	RAV-SP180AT2-UL	RAV-SP240AT2-UL	RAV-SP300AT2-UL	RAV-SP360AT2-UL	RAV-SP420AT2-UL



24V Interface for Third-Party Thermostat

FEATURES

- Control the Ductless System using a third-party thermostat¹
- One 24V Interface Kit per indoor head²
- Single and multi-zone applications
- Keeps the Inverter compressor operating as a variable-speed system³
- Rated for outdoor and indoor mounting
- Dry mode contact for active dehumidification control
- Remote on/off contact
- Auxiliary heat control through the thermostat⁴
- Diagnostic code display LEDs
- Power supplied through the outdoor unit

COMPATIBLE WITH:

- 40MPHA High Wall (p 24)
- 40MAHB High Wall (p 30)
- 40MHH High Wall (p 44)
- 40MBCQ Cassette (p 32)
- 40MBDQ Ducted (p 34)
- 40MBFQ Console (p 38)

KSAIC0301230 Ductless Indoor + Outdoor Single Zone 208–230V

KEY FEATURES:

Maintain Inverter Compressor Technology

The new 24V Interface keeps the Inverter compressor operating as a variable-speed system when using a third-party thermostat, making adjustments to maintain more consistent operation.

Easy & Flexible Installation

Experience quick and easy installation between either a single or multi-zone outdoor unit and the fan coil. The interface can be installed either indoors or outdoors.

Consumer Choice & Control

Consumers can choose the type of thermostat they want to use without adversely affecting the efficiency or performance of their Ductless Systems.

ACCESSORIES:

- 115V Transformer RCD#11203103000393 (Used only on Ductless Systems with 115V power.)

COMPATIBILITY:

Compatibility Table				
Type of Indoor Unit	Indoor Family Name	Single Zone Outdoor Family Name	Multi-Zone Outdoor Family Name	208/230V
High Wall	40MPHA	38MPRA	38MGR	All Sizes
	40MAHB	38MARB	38MGR	All Sizes
	40MHH	38MHR	38MGR	All Sizes
Cassette	40MBCQ	38MARB	38MGR	All Sizes
Ducted	40MBDQ	38MARB	38MGR	All Sizes Except Size 58 (See Note)
Console	40MBFQ	38MARB	38MGR	All Sizes Except Sizes 12 and 58 (See Note)

Note: The indoor unit requires an updated control board for compatibility with the 24V Interface Kit. High Wall units starting with Serial #4316V10001 are shipped with the compatible control board. Ducted units starting with Serial #4616V10001 are shipped with the compatible control board. For other model numbers not shown on the table above, please contact your ductless representative. Ducted size 58 Console sizes 12 and 58 starting with serial #1419V1001 are shipped with compatible control board.

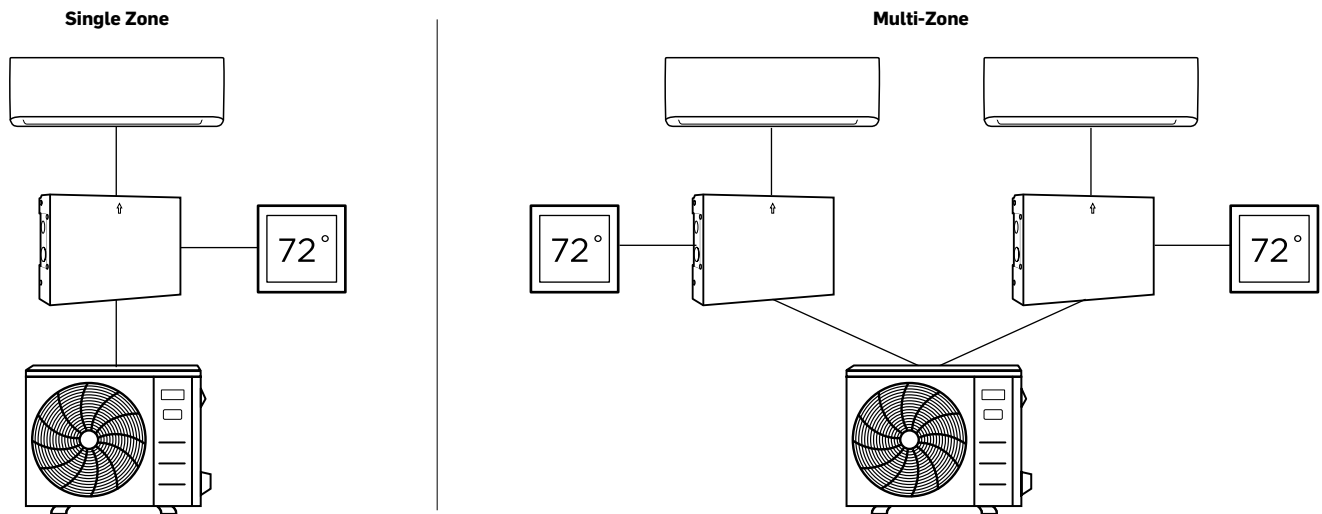

Notes:

- ¹ Third-party thermostats used with the 24V Interface Kit will replace the wireless Remote Controller included with the unit. Consult with dealer for more information.
- ² When using in a Multi-Zone System not all the indoor heads require a 24V Interface Kit.
- ³ A conventional 5-wire thermostat is required.
- ⁴ A secondary output is necessary for auxiliary heat control.



24V Interface for Multi-Family Air Handler

FEATURES

- Match a multi-family air handler with a single zone outdoor and a third-party thermostat¹
- One 24V Interface Kit per system
- Keeps the Inverter compressor operating as a variable-speed system²
- Rated for outdoor and indoor mounting
- Remote on/off contact
- Auxiliary heat control through the thermostat³
- Diagnostic code display LEDs

COMPATIBLE WITH:

- 38MARB Outdoor Unit Single Zone
- FMA4 Vertical Fan Coil
- FMC Cased Horizontal Fan Coil
- FMU Uncased Horizontal Fan Coil
- FV4C Fan Coil

KSAIC0301230 Ductless Outdoor*** Matched With Multi-Family Air Handler

KEY FEATURES:

Easy & Flexible Installation

Experience quick and easy installation of the condensing unit, the 24V Interface and the fan coil or furnace/cased coil. Features like customizable airflow adjustments and self-configuring/diagnostic capabilities ensure application flexibility and easier servicing, benefitting contractors and multi-family property managers.

Off-the-shelf Combinations

Reduce inventory management by using the 38MARB Variable Speed Condensing unit, fan coils, furnaces and cased coils that are already available.

No Additional Heat Strip Needed

Due to the high heating capabilities, there is no need to purchase an additional heat strip to be installed on site, which reduces costs and installation times.

Note: Indoor unit's TXV/Piston required to be removed. It is recommended to use the Piping Adaptor Kit RCD#331831-701 sold separately facilitating the piping installation.

COMPATIBILITY:

Compatibility Table			
Indoor Unit	Nominal System Size MBTUH	Outdoor Model Number	Indoor Model Number
FMA4 Vertical Fan Coil	12	38MARBQ12AA3	FMA4X1800AL1
	18	38MARBQ18AA3	FMA4X1800AL1
	24	38MARBQ24AA3	FMA4X2400AL1
	30	38MARBQ30AA3	FMA4X3000AL1
	36	38MARBQ36AA3	FMA4X3600AL1
FMC Cased Horizontal Fan Coil	12	38MARBQ12AA3	FMC4Z1800AL1
	18	38MARBQ18AA3	FMC4Z1800AL1
	24	38MARBQ24AA3	FMC4Z2400AL1
	30	38MARBQ30AA3	FMC4Z3000AL1
	36	38MARBQ36AA3	FMC4Z3600AL1
FMU Uncased Horizontal Fan Coil	12	38MARBQ12AA3	FMU4Z1800AL1
	18	38MARBQ18AA3	FMU4Z1800AL1
	24	38MARBQ24AA3	FMU4Z2400AL1
	30	38MARBQ30AA3	FMU4Z3000AL1
	36	38MARBQ36AA3	FMU4Z3600AL1
FV4C Fan Coil	12	38MARBQ12AA3	FV4CNF002L00
	18	38MARBQ18AA3	FV4CNF002L00
	24	38MARBQ24AA3	FV4CNF002L00
	30	38MARBQ30AA3	FV4CNF003L00
	36	38MARBQ36AA3	FV4CNF003L00

Note: The FMA4P units are not an acceptable match with these condensing units due to the PSC motor.

Select Proper Blower Speed

Before operating the unit, ensure that the proper blower speed has been selected. Fan speeds are selected manually. Refer to the installation manual of the indoor unit for instructions on how to change the fan speed on the indoor fan coil and select the taps (see Compatibility Table) for the proper matches.

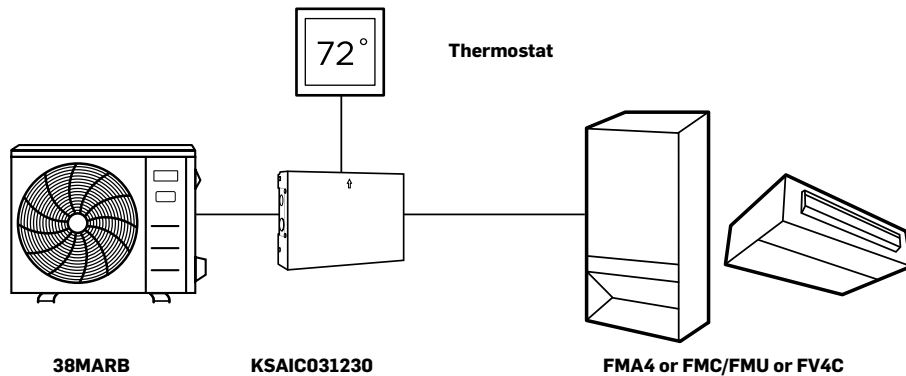

Notes:

¹ Third-party thermostats used with the 24V Interface Kit will replace the wireless Remote Controller included with the unit. Consult with dealer for more information.

² A conventional 5-wire thermostat is required.

³ A secondary output is necessary for auxiliary heat control.

COMPATIBILITY CONTROLS:



**Optional
Wired Controller
(Timer Function)
KSACN0101AAA**



**Optional
Wired Controller
(7-Day Programmable)
KSACN0601AAA,
KSACN0701AAA or
KSACN0801AAA**

Indoor Unit Type			High Wall			Cassette	Ducted	Console	Air Handler
	Indoor Family Name	Single Zone/Multi-Zone	40MPHA	40MAHB	40MHH	40MBCQ	40MBDQ	40MBFQ	40MBAA
Wired Controllers	KSACN0101AAA	Single Zone & Multi-Zone		○	○	○	○	○	
	KSACN0401AAA	Single Zone & Multi-Zone	○		○			○ 9-12 ‡	
	KSACN0501AAA	Single Zone & Multi-Zone				○	●	○ 18-58	
	KSACN0601AAA	Single Zone & Multi-Zone	○		○			○ 9-12 ‡	
	KSACN0701AAA	Single Zone & Multi-Zone				○	●**	○ 18-58	
	KSACN0801AAA	Single Zone & Multi-Zone		○					
24V Interface	KSAIC0301230	Single Zone & Multi-Zone	○	○ 230V	○ 230V	○	○	○ 12-58-	BUILT-IN
Wi-Fi® Kits	KSAIF0101AAA	Single Zone & Multi-Zone			○ 9/12/24k				
	KSAIF0201AAA	Single Zone & Multi-Zone			○ 18k				
	KSAIF0301AAA	Single Zone & Multi-Zone	↔	↔	↔				
	KSAIF0401AAA	Single Zone & Multi-Zone				○	○	○ 18-58	
	KSAIF0601AAA	Single Zone & Multi-Zone	●	○					

○	Optional
●	Standard

Not available / compatible
Current models

Notes:

‡ Compatible with indoor units starting with Serial Number 0117V10001.

** Starting with Serial Number 2820V10001 (Week 28, Year 2020) the KSACN0701AAA became the standard controller but is backwards compatible with previous production units.

« 24V Interface compatible with all the sizes except sizes 12 and 58 depending on serial number. Starting with Serial Number 1419V10001 the sizes 12 and 58 are shipped with the compatible control board. Units built prior these serial number would require a Control Board Replacement on the Indoor unit in order to be compatible.

↔ Indoor unit model comes with everything to be compatible with the USB WiFi Dongle Model 17310900000281 from the KSAIF0301AAA kit. If installed in a high wall unit other than the 40MAQ, install the USB WiFi Dongle 17310900000281 into the high wall unit's factory USB port only and discard all other components of the KSAIF0301AAA kit.

Board replacement for forward compatibility is not covered as a warranty claim

WI-FI® SMARTPHONE CONTROL COMPATIBILITY:

The use of the Wi-Fi® Accessory Kits on some indoor units would disable the ability to use the Wired Controllers in some instances:

		Wired Control	Wireless Control
High-Tier High Wall	40MPHA	●	●
Mid-Tier High Wall	40MAHB		●
Entry-Tier High Wall	40MHH		●
Ducted	40MBCQ	●	●
Cassette	40MBDQ	●	●
Console 18-58	40MBFQ	●	●

Note:

The use of the 24V interface will disable system's Wi-Fi® module. Please consider using a Wi-Fi® Thermostat when using the 24V interface.

Wi-Fi® kits cannot be used on networks requiring a user login.

Wi-Fi® kits are only supported with networks using WPA-PSK/WPA2-PSK encryption and no encryption. WPA-PSK/WPA2-PSK encryption is recommended.

Please consult the installation instructions and Owners Manuals of the individual kits for more information.

STANDARD FEATURES GLOSSARY

24-Hour Timer

Set the unit to start and stop automatically in a 24-hour period.

Airflow Panel

360° air outlet creates a soft and gentle airflow, which circulates throughout the whole space and provides an even temperature distribution in the room.

Auto Defrosting

Prevents the evaporator from freezing and maintains dehumidifying effect in low temperature environments.

Auto Restart Function

If the air conditioner shuts off unexpectedly due to a power outage, it will restart with the previous settings automatically when the power resumes.

Built-In Basepan Heater

A heating belt is fitted on the base plate of the outdoor unit to prevent water accumulation, which improves heat transfer efficiency.

Built-In Condensate Lift Pump

A powerful, built-in drain pump can lift the condensing water up to 29 inches.

Control Box Inside the Cassette

Easy maintenance with the box right inside the Cassette indoor unit. The integrated design provides a more compact size for easier installation.

Convenient Temperature Controls

An intuitive, easy-to-use remote control displays temperature and other functions on a bright, clear LCD screen.

Convertible Return Air Inlet

The air inlet can be installed either at the back or bottom of the ducted unit, allowing for flexible installation to meet the needs of each job.

Crankcase Heater

A heating belt is fitted on the compressor to prevent frosting water accumulation, which improves heat transfer efficiency.

Diamond Outdoor Unit Design

An innovative outdoor unit reduces noise level by more than 3 dB(A), with higher reliability, easier maintenance and improved performance.

Eco Mode

Provides the ultimate energy savings and a comfortable sleeping environment with an intelligent eight-hour night cycle program that saves up to 60% of energy.

Extra-Low Temperature Heating

When it's cold outside, it's warm inside. High Tier and Mid-Tier Ductless systems can be used as a primary heat source, with heat output down to -22° F.

Follow Me

A temperature sensor built into the Remote Controller will sense its surrounding temperature. The unit will adjust the room temperature more accurately to give you comfort.

High Ambient Cooling

The indoor space can be cooled to a desired, comfortable indoor temperature, even when outside temperatures reach up to 122°F.

High Heating Operation

The High Tier and Mid-Tier systems can be a primary heat source, with High Heating down to -22°F, so when it's cold outside, it's warm inside.

Independent Vane Control

Airflow direction from individual outlets can be controlled separately to achieve the optimal airflow based on a room's configuration.

Inverter Technology

With the Inverter, the outdoor unit uses only the energy required to meet the desired temperature requirements of the indoor unit, thus lowering energy consumption.

Louver Position Memory

A horizontal louver will automatically move to the same position that was set the last time the unit was on.

Low Ambient Cooling

Even when it's cold outside, but warm inside, the air conditioner will keep the area cool – perfect for server rooms and commercial kitchens.

Refrigerant Leak Detection

The indoor unit shows error code "EC" and stops automatically when refrigerant leakage is detected. This protects the compressor from high temperature damage due to refrigerant leakage.

Single and Multi-Zone Compatible

A Single Zone outdoor unit can be paired with any indoor unit type. One Multi-zone unit can be leveraged for up to five indoor units of any style.

Sleep Mode

This function enables the system to automatically increase cooling or decrease heating by around four degrees for the first two hours, then holds steady for the next five hours. After that, it will switch off. This function achieves both energy savings and comfort at night.

Stepless Frequency Adjustment

Precise control maintains a stable and constant room temperature while reducing the sound level and saving energy.

Two-Way Draining

Connections, piping and drainage can be installed from both the left and right on the High Wall.

Universal Matching

Get maximum flexibility with up to five different indoor units connected to one outdoor unit. Maintain a different temperature in each room for ultimate comfort, with the best indoor unit choice for each. Universal matching units are also available for Single Zone outdoor units. One outdoor unit can match any type of indoor unit.

Wired Remote Controller

Compared to an infrared remote controller, a Wired Controller can be fixed on the wall and makes air conditioner operation more convenient for larger setups or ducted units.



SANKS
Mechanical

13451 Damar Dr Suite JK, Philadelphia PA 19116
Contact: (267) 722-4052
www.sanksmechanical.com

Carrier

